

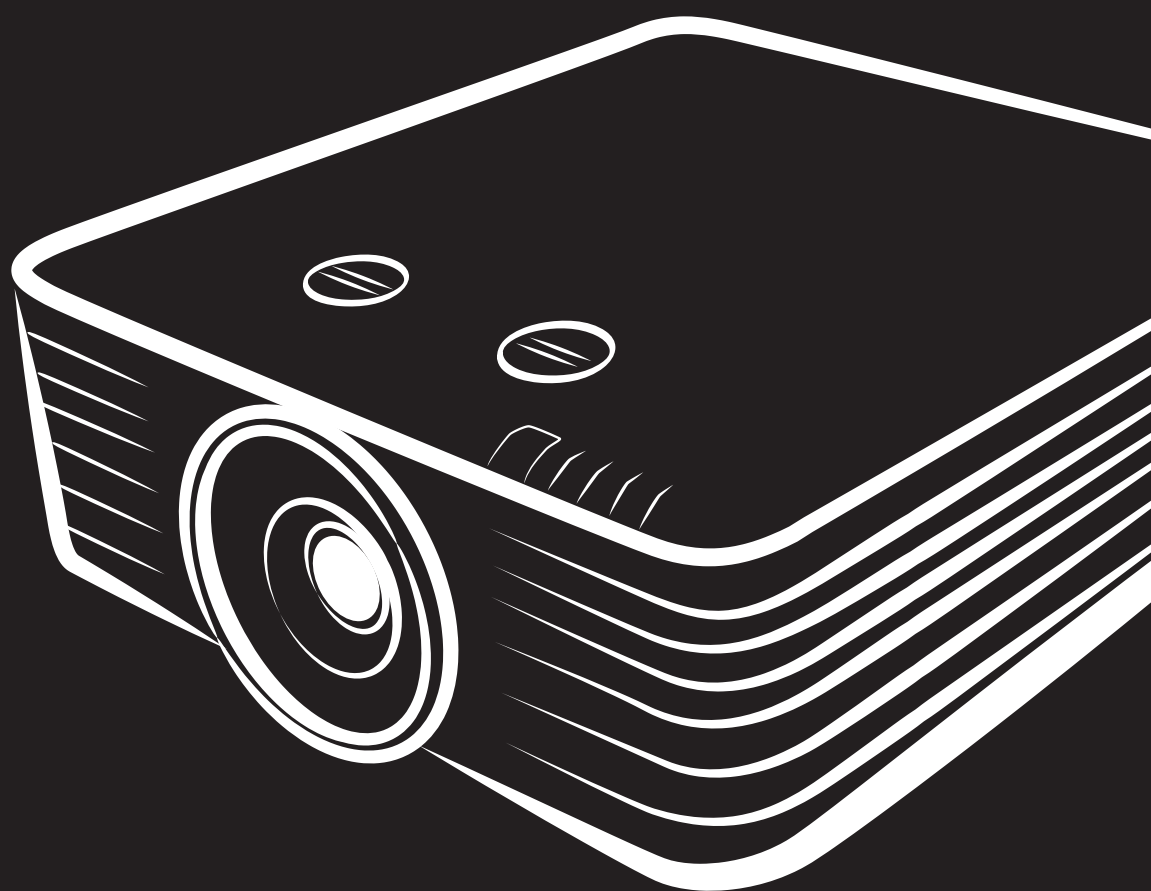

User Manual

# DU70x Series



## Copyright

This publication, including all photographs, illustrations and software, is protected under international copyright laws, with all rights reserved. Neither this manual, nor any of the material contained herein, may be reproduced without written consent of the author.

© Copyright 2017

## Disclaimer

The information in this document is subject to change without notice. The manufacturer makes no representations or warranties with respect to the contents hereof and specifically disclaims any implied warranties of merchantability or fitness for any particular purpose. The manufacturer reserves the right to revise this publication and to make changes from time to time in the content hereof without obligation of the manufacturer to notify any person of such revision or changes.

## Trademark Recognition



Kensington is a U.S. registered trademark of ACCO Brand Corporation with issued registrations and pending applications in other countries throughout the world.



HDMI, the HDMI Logo, and High-Definition Multimedia Interface are trademarks or registered trademarks of HDMI Licensing LLC in the United States and other countries.



MHL, the MHL logo, and Mobile High-Definition Link are trademarks or registered trademarks of MHL licensing, LLC.



HDBaseT™ and the HDBaseT Alliance logo are trademarks of the HDBaseT Alliance.

All other product names used in this manual are the properties of their respective owners and are acknowledged.

## Important Safety Information



**Important:**

*It is strongly recommended that you read this section carefully before using the projector. These safety and usage instructions will ensure that you enjoy many years of safe use of the projector. Keep this manual for future reference.*

### Symbols Used

Warning symbols are used on the unit and in this manual to alert you of hazardous situations.

The following styles are used in this manual to alert you to important information.

**Note:**

*Provides additional information on the topic at hand.*



**Important:**

*Provides additional information that should not be overlooked.*



**Caution:**

*Alerts you to situations that may damage the unit.*



**Warning:**

*Alerts you to situations that may damage the unit, create a hazardous environment, or cause personal injury.*

Throughout this manual, component parts and items in the OSD menus are denoted in bold font as in this example:

“Push the **Menu** button on the remote control to open the **Main** menu.”

### General Safety Information

- Do not open the unit case. There are no user-serviceable parts in the unit. For servicing, contact qualified service personnel.
- Follow all warnings and cautions in this manual and on the unit case.
- To avoid damage to eyes, do not look into the lens when the light source is on.
- Do not place the unit on an unstable surface, cart, or stand.
- Avoid using the system near water, in direct sunlight, or near a heating device.
- Do not place heavy objects such as books or bags on the unit.

### Notice

This product is intended for the adults who have the ability to operate this machine.

Please write down your projector model number and serial number and keep the information for maintenance purposes in the future. Should the equipment be lost or stolen, the information could also be used for the police report.

Model number:

Serial number:

## LASER WARNING



This symbol indicates that there is a potential hazard of eye exposure to laser radiation unless the instructions are closely followed.

### CLASS 3R LASER PRODUCT



This Laser Product is designated as Class 3R during all procedures of operation. **LASER LIGHT - AVOID DIRECT EYE EXPOSURE.**

Do not point laser or allow laser light to be directed or reflected toward other people or reflective objects .

Direct or scattered light can be hazardous to eyes and skin.



There is a potential hazard of eye exposure to laser radiation if the included instructions are not followed.

Caution – use of controls or adjustments or performance of procedures other than those specified herein may result in hazardous radiation exposure

### Laser Parameters

Wavelength	450nm - 460nm (Blue)
Mode of operation	Pulsed, due to frame rate
Pulse width	1.34ms
Pulse repetition rate	120Hz
Maximum laser energy	0.698mJ
Total internal power	>100w
Apparent source size	>10mm, at lens stop
Divergence	>100 mili Radian

**Product labels**

Below drawing show the label's location

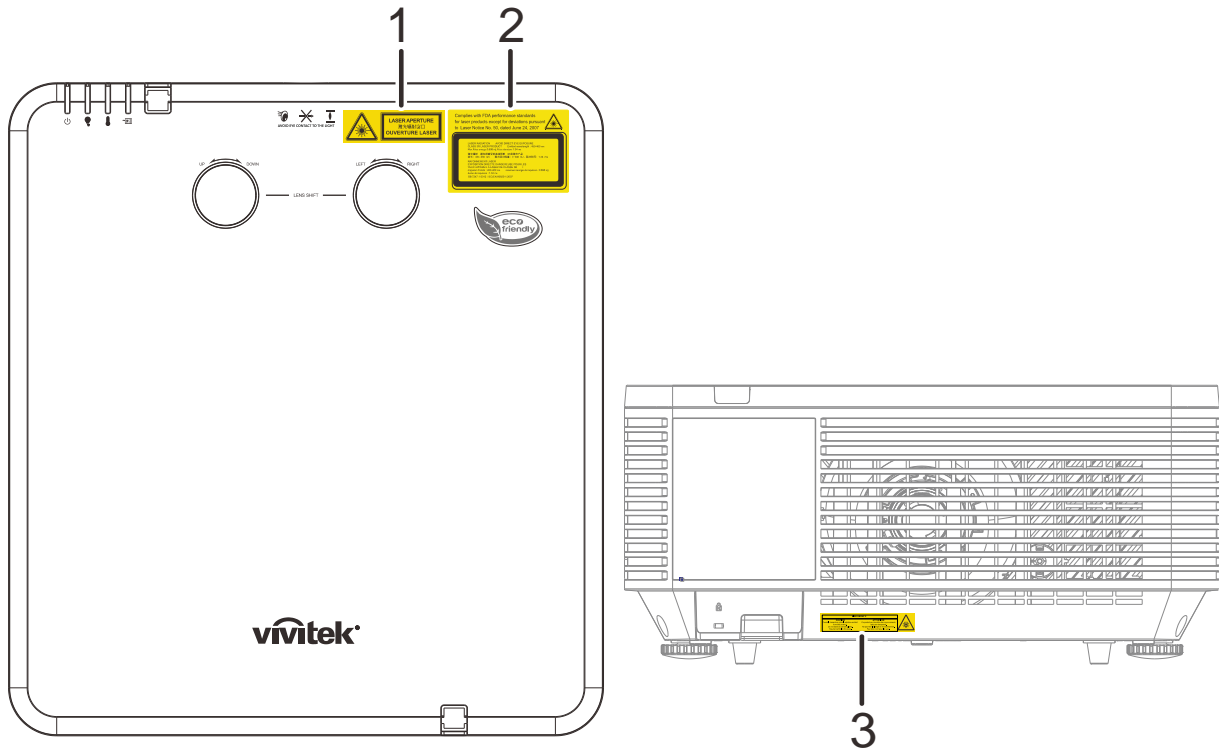

**1.** Hazard Warning Symbol and Aperture Label



**2.** Explanatory Label

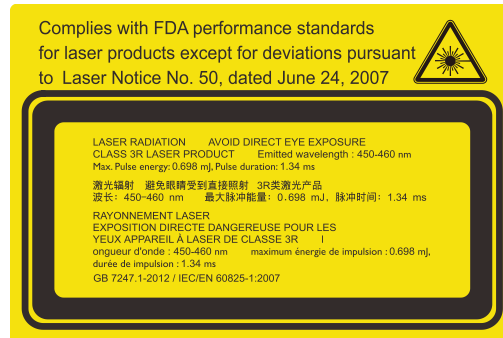

**3.** Explanatory Label

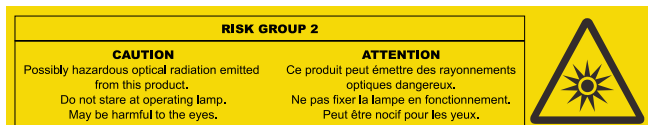

### **Location of laser aperture**

Below drawing is the laser aperture location. Be careful not to let the eye see the light directly.

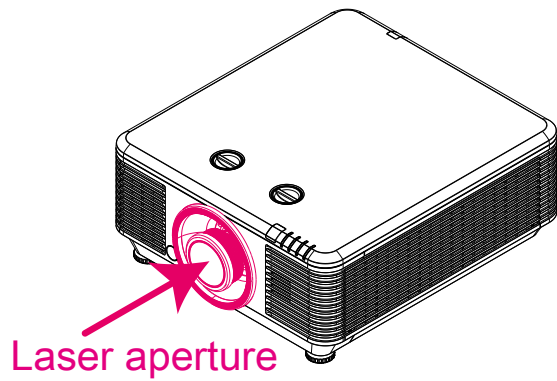

### **Interlock switches**

This machine has 2 (Top cover x 1, Lens x 1) Interlock switches to protect the laser light Leakage.

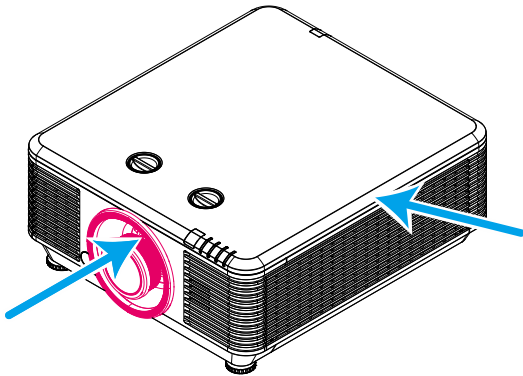

1. Will power-off the system individually when the top cover is removed.
2. Will power-off the system individually when the lens is removed or not install correctly.

**Projector Installation Notice**

- **There is no limitation angle for projector installation.**

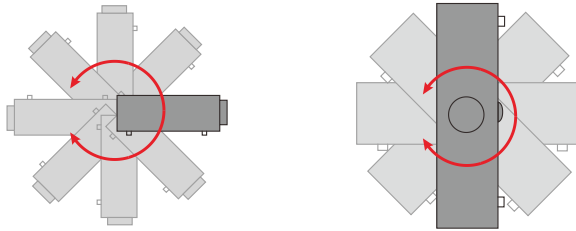

- Allow at least 50 cm clearance around the exhaust vent.

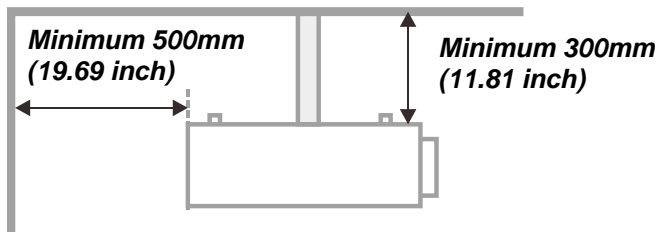
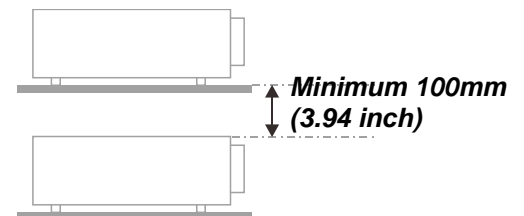
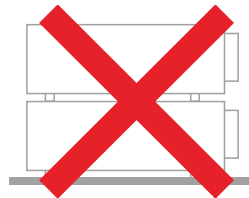
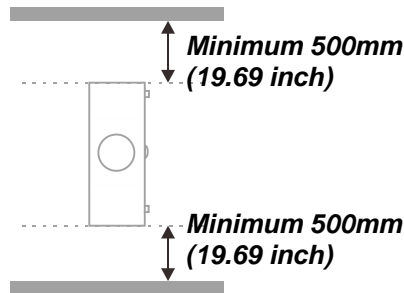
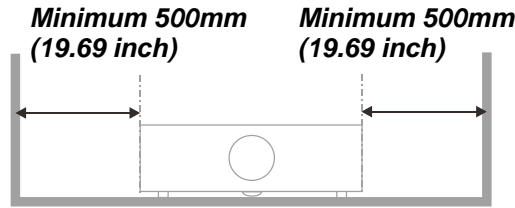
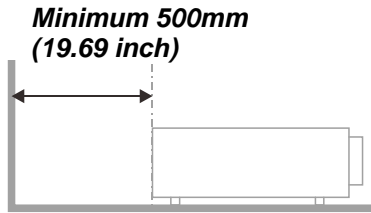

- Ensure that the intake vents do not recycle hot air from the exhaust vent.
- When operating the projector in an enclosed space, ensure that the surrounding air temperature within the enclosure does not exceed operation temperature while the projector is running, and the air intake and exhaust vents are unobstructed.
- All enclosures should pass a certified thermal evaluation to ensure that the projector does not recycle exhaust air, as this may cause the device to shutdown even if the enclosure temperature is within the acceptable operation temperature range.

### **Verify Installation Location**

- To supply power, the 3-blade (with earthing lead) socket should be used to ensure proper grounding and equalized ground potential for all of the equipment in the Projector System.
- The power code provided with the Projector should be used. In case of any missing item, other qualified 3-blade (with earthing lead) power cord can be used as substitution; however, do not use 2-blade power cord.
- Verify if the voltage is stable, grounded properly and there is no electricity leakage.
- Measure total power consumption which should not higher the safety capacity and avoid safety issue and short circuit.
- Turn on Altitude Mode when located in high altitude areas
- The projector can only be installed upright or inverted.
- When installation the bracket, make sure the weight limit is not exceed and firmly secured.
- Avoid installing near air conditioner duct or subwoofer.
- Avoid installing at high temperature, insufficient cooling and heavy dust locations.
- Keep your product away from fluorescent lamps (>1 Meter) to avoid malfunction caused by IR interference
- The VGA IN connector should be connected to the VGA IN port. Note that it should be inserted tightly, with the screws on both sides securely fastened to ensure proper connection of the signal wire for achieving optimal display effect.
- The AUDIO IN connector should be connected to the AUDIO IN port and CANNOT be connected to AUDIO OUT or other ports like BNC, RCA; otherwise, it will lead to mute output and even DAMAGE the port.
- Install the projector above 200cm to avoid damage.
- The power cord and signal cable should be connected before power on the projector. During the projector starting and operating process, DO NOT insert or remove the signal cable or the power cord to avoid damaging the projector.

### **Cooling notes**

#### **Air outlet**

- Make sure the air outlet is 50cm clear of any obstruction to ensure proper cooling.
- Air outlet location should not be in front of the lens of other projector to avoid causing illusions.
- Keep the outlet at least 100cm away from the inlets of other projectors
- The projector generates a massive amount of heat during use. The internal fan dissipates the heat of the projector when shutting down, and such process may continue for a certain period. After the project enters STANDBY MODE status, press the AC power button to turn off the projector and remove the power cord. DO NOT remove the power cord during the shutdown process, as it may cause damage to the projector. In the meantime, the delayed heat radiating will also affect the service life of the projector. The shutdown process may vary depending on the model used. Whatever the case may be, be sure to disconnect the power cord till after the projector enters the STANDBY status.

#### **Air inlet**

- Make sure there is no object blocking air input within 30 cm.
- Keep the inlet away from other heat sources
- Avoided heavy dust area



### **Power Safety**

- Only use the supplied power cord.
- Do not place anything on the power cord. Place the power cord where it will not be in the way of foot traffic.
- Remove the batteries from the remote control when storing or not in use for a prolonged period.

### **Cleaning the Projector**

- Unplug the power cord before cleaning. See [Cleaning the Projector](#) page 57.
- Allow the light source to cool for about one hour.

### **Regulatory Warnings**

Before installing and using the projector, read the regulatory notices in the [Regulatory Compliance](#) on page 74.

### **Symbol Explanations**



**DISPOSAL:** Do not use household or municipal waste collection services for disposal of electrical and electronic equipment. EU countries require the use of separate recycling collection services.

### **Special Care for Laser Beams!**

Special care should be considered when DLP projectors and high power laser equipment are used in the same room as.

Direct or indirect hit of a laser beam on to the projector lens can severely damage the Digital Mirror Devices (DMD™).

### **Sun light Warning**

Avoid using in direct sun light.

Sun light on the projector lens can severely damage the Digital Mirror Devices (DMD™).

## Main Features

- *Compatible with all major video standards including NTSC, PAL, and SECAM.*
- *A high brightness rating allows for presentations in daylight or in lit rooms.*
- *Flexible setup allows for front, rear projections.*
- *Line-of-vision projections remain square, with advanced keystone correction for angled projections.*
- *Input source automatically detected.*
- *High brightness for projection in just about any environment.*
- *Supports resolutions up to WUXGA for clear and crisp images.*
- *DLP® and BrilliantColor™ technologies from Texas Instruments.*
- *Centered lens for easy installation.*
- *Horizontal and vertical lens shift.*
- *MHL device compatibility for streaming of video and audio content from a compatible mobile device.*
- *Built-in speaker with multiple audio-in and audio-out ports.*
- *Network ready for integration and system administration via RJ45.*
- *Sealed engine to minimizing the impact of dust and smoke.*
- *Anti-theft security features include: Kensington security slot, security bar.*
- *Built-in HDBaseT receiver. HDBaseT™ interface with support for distribution of HD video, digital audio content RS232, RJ45 and IR function over standard CAT5e/6 LAN cable*
- *Advanced laser phosphor light engine for superior brightness and color uniformity*
- *Laser design deliveries up to 20,000 hours of operational time*

## About this Manual

This manual is intended for end users and describes how to install and operate the DLP projector. Wherever possible, relevant information—such as an illustration and its description—has been kept on one page. This printer-friendly format is both for your convenience and to help save paper, thereby protecting the environment. It is suggested that you only print sections that are relevant to your needs.

**Table of Contents**

**GETTING STARTED..... 1**

- PACKING CHECKLIST ..... 1
- VIEWS OF PROJECTOR PARTS..... 2
  - Front-right View* ..... 2
  - Top view* ..... 3
  - Side view—On-Screen Display (OSD) buttons and IO*..... 4
  - Bottom view*..... 6
- REMOTE CONTROL PARTS ..... 8
- REMOTE CONTROL OPERATING RANGE..... 11
- PROJECTOR AND REMOTE CONTROL BUTTONS..... 11

**SETUP AND OPERATION..... 12**

- INSERTING THE REMOTE CONTROL BATTERIES ..... 12
- INSTALLING OR REMOVING THE OPTIONAL LENS ..... 13
  - Installing the New Lens* ..... 13
  - Removing the Existing Lens From the Projector*..... 14
- STARTING AND SHUTTING DOWN THE PROJECTOR..... 15
- SETTING AN ACCESS PASSWORD (SECURITY LOCK)..... 17
- ADJUSTING THE PROJECTOR LEVEL ..... 19
- ADJUSTING PROJECTED IMAGE POSITION USING LENS SHIFT ..... 20
  - Adjusting the vertical image position*..... 20
  - Adjusting the horizontal image position* ..... 21
  - Shift Range Diagram* ..... 21
- ADJUSTING THE ZOOM, FOCUS AND KEYSTONE ..... 22
- ADJUSTING THE VOLUME ..... 23

**ON-SCREEN DISPLAY (OSD) MENU SETTINGS..... 24**

- OSD MENU CONTROLS ..... 24
  - Navigating the OSD* ..... 24
- SETTING THE OSD LANGUAGE ..... 25
- OSD MENU OVERVIEW ..... 26
- IMAGE MENU..... 29
  - Computer Menu*..... 30
  - Advanced Feature*..... 31
  - White Balance*..... 32
  - Color Manager*..... 33
- SETTINGS 1 MENU ..... 34
  - Keystone*..... 35
  - Audio*..... 35
  - Advanced 1 Feature*..... 36
  - Advanced 2 Feature* ..... 38
  - 4 Corner*..... 39
- SETTINGS 2 MENU ..... 40
  - Status*..... 41
  - Advanced 1 Feature*..... 42
  - Advanced 2 Feature*..... 55

**MAINTENANCE AND SECURITY ..... 57**

- CLEANING THE PROJECTOR..... 57
  - Cleaning the Lens* ..... 57
  - Cleaning the Case*..... 57
  - Cleaning the Air Filter* ..... 58
- REPLACING THE FILTER ..... 59
- USING THE PHYSICAL LOCK ..... 61
  - Using the Kensington Security Slot*..... 61
  - Using the Security Bar Lock*..... 61

**TROUBLESHOOTING..... 62**

---

COMMON PROBLEMS AND SOLUTIONS.....	62
TIPS FOR TROUBLESHOOTING .....	62
LED ERROR MESSAGES.....	63
IMAGE PROBLEMS.....	63
LIGHT SOURCE PROBLEMS.....	64
REMOTE CONTROL PROBLEMS .....	64
AUDIO PROBLEMS .....	64
HAVING THE PROJECTOR SERVICED .....	64
HDMI Q & A .....	65
<b>SPECIFICATIONS.....</b>	<b>66</b>
SPECIFICATIONS.....	66
PROJECTION DISTANCE VS. PROJECTION SIZE.....	68
<i>Projection Distance and Size Table</i> .....	68
TIMING MODE TABLE .....	70
<i>Table of Supported Frequency</i> .....	70
<i>Table of Supported Frequency For 3D mode</i> .....	72
PROJECTOR DIMENSIONS .....	73
<b>REGULATORY COMPLIANCE.....</b>	<b>74</b>
FCC WARNING.....	74
CANADA .....	74
SAFETY CERTIFICATIONS.....	74
<b>APPENDIX I.....</b>	<b>75</b>
COMMUNICATION PARAMETER SETUP.....	75

## GETTING STARTED

### Packing Checklist

Carefully unpack the projector and check that the following items are included:

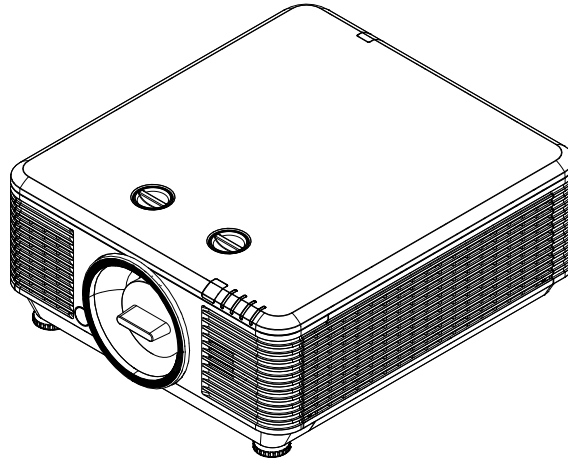

Projector



Remote Control  
(Batteries Included)

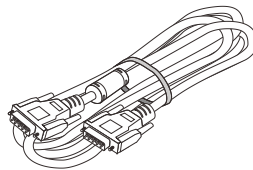

VGA Cable (1.8m)

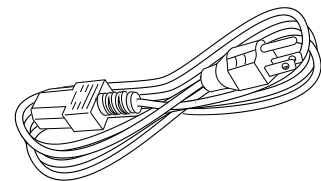

Power Cord (1.8m)



CD-ROM  
(This User's Manual)



Warranty Card



Quick Start Guide

Contact your dealer immediately if any items are missing, appear damaged, or if the unit does not work. It is recommended that you keep the original packing material should you ever need to return the equipment for warranty service.



**Caution:**  
Avoid using the projector in dusty environments.

**Views of Projector Parts**

Front-right View

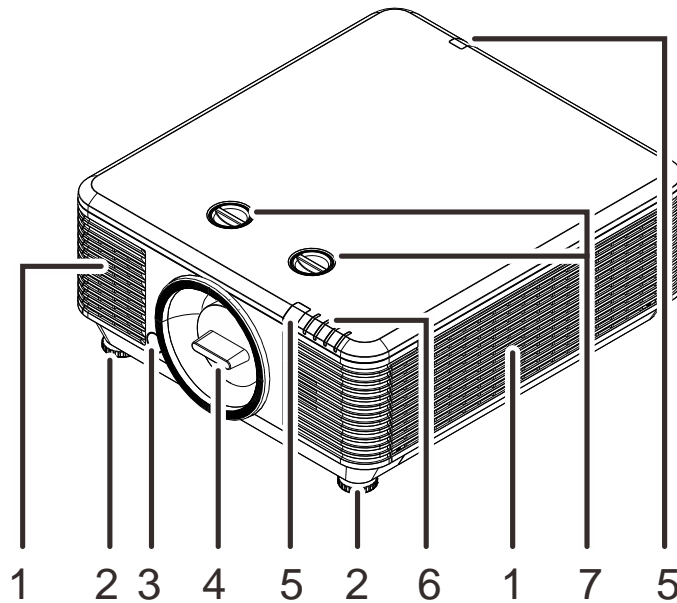

ITEM	LABEL	DESCRIPTION	SEE PAGE:
1.	Vent	Cool air intake.	
2.	Tilt Adjuster	Rotate adjuster lever to adjust angle position.	<a href="#">19</a>
3.	Lens Release Button	For release Lens.	<a href="#">14</a>
4.	Anti-dust cap	Anti-dust cap	
5.	IR Receiver	Receives IR signal from remote control.	<a href="#">7</a>
6.	LEDs	Displays the projector status.	<a href="#">3</a>
7.	Lens Shift	Adjusts the image position.	<a href="#">20</a>



**Important:**

Ventilation openings on the projector allow for good air circulation, which keeps the projector light source cool. Do not obstruct any of the ventilation openings.

Top view

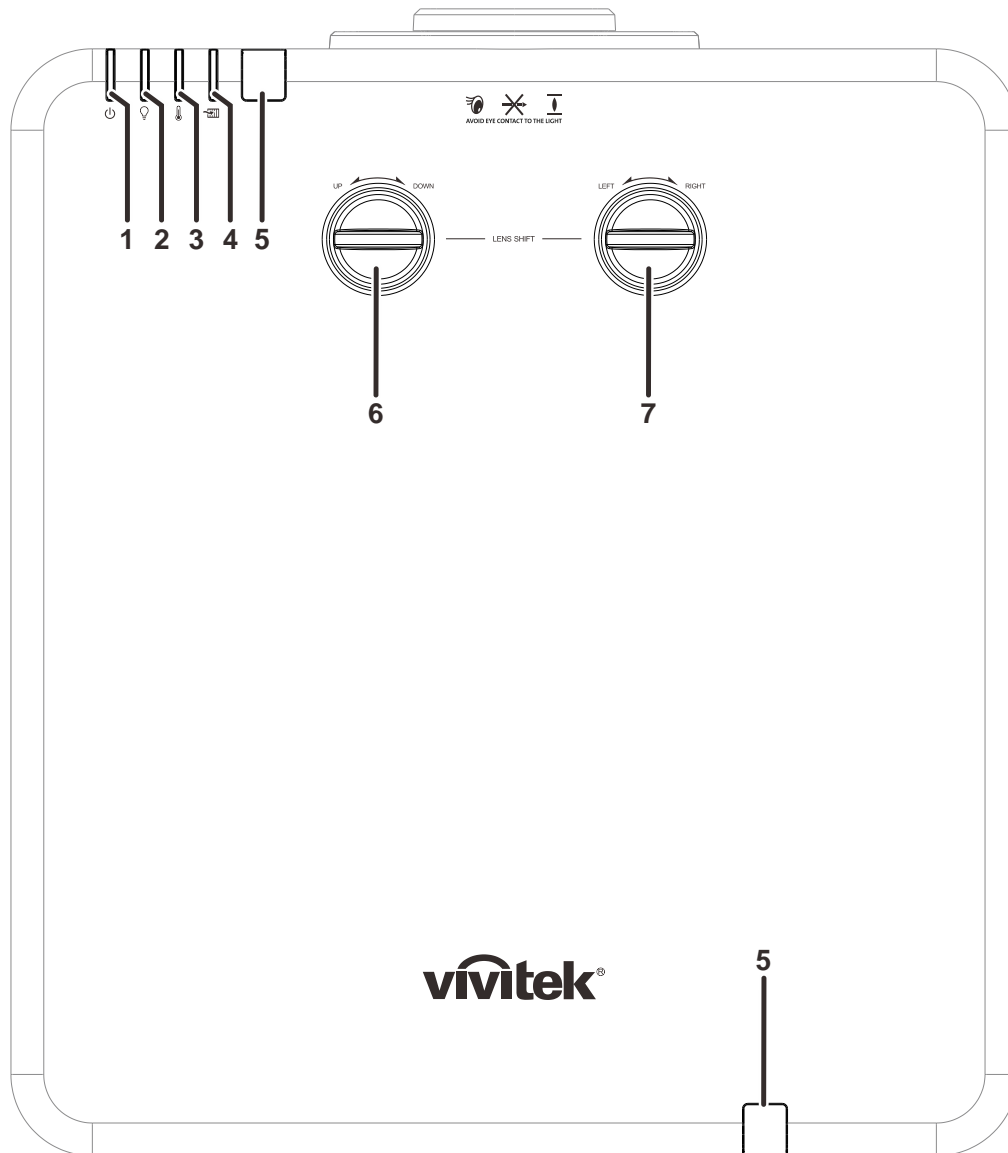

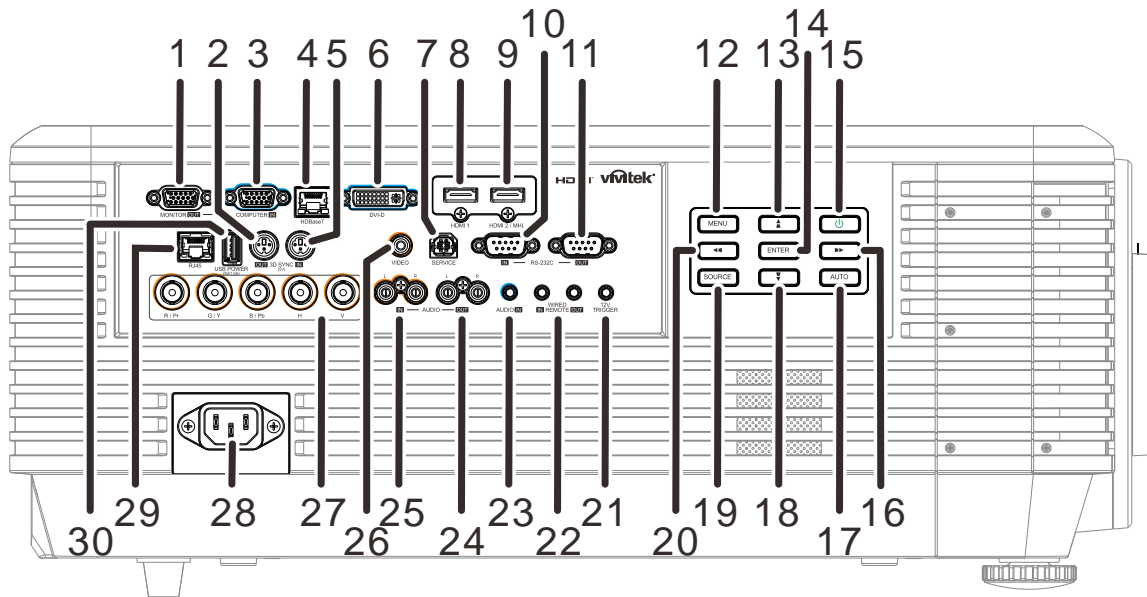

ITEM	LABEL	DESCRIPTION	SEE PAGE:
1.	Power LED	Display the power on/off sequence status.	<b>63</b>
2.	Light source LED	Display the light source status.	<b>63</b>
3.	Temp LED	Display the thermal status.	<b>63</b>
4.	Filter LED	Display the filter replacing warning message.	<b>63</b>
5.	IR Receiver	Receives IR signal from remote control.	<b>7</b>
6.	Vertical Lens Shift (UP / DOWN)	Adjusts the image position vertically.	<b>20</b>
7.	Horizontal Lens Shift (LEFT / RIGHT)	Adjusts the image position horizontally.	<b>21</b>

Side view—On-Screen Display (OSD) buttons and IO



ITEM	LABEL	DESCRIPTION	SEE PAGE:
1.	MONITOR OUT	Connect an RGB cable to a display.	
2.	3D-SYNC OUT (5V)	Connect 3D IR glasses receiver unit.	
3.	COMPUTER IN	Connect an RGB cable from a computer or a video enabled device.	
4.	HDBaseT	Connect Cat5e/Cat6 cable from HDBaseT TX Box (VIDEO EXTENDER) for HDBaseT signal received.	
5.	3D-SYNC IN (5V)	Connect 3D-sync in cable from a computer or an enabled device.	
6.	DVI-D	Connect the DVI CABLE to display.	
7.	SERVICE	For service personnel only.	
8.	HDMI 1	Connect the HDMI cable from an HDMI device.	
9.	HDMI 2 / MHL	Connect the HDMI/MHL cable from an HDMI/MHL device. <b>Note:</b> Set the Source to HDMI 2/MHL also can be charging connected MHL compatible smart device as long as the projector Power On.	
10.	RS-232C IN	Connects RS-232 serial port cable for remote control.	
11.	RS-232C OUT	Connects to another projector (same model) for RS-232 control.	
12.	MENU	Opens and exits OSD menus.	24
13.	▲ ▲	Navigates and changes settings in the OSD. Quick Menu – For Vertical Keystone.	24
14.	ENTER	Enter or confirm highlighted OSD menu item.	24
15.	Power	Turn the projector on or off.	15
16.	▶▶	Navigates and changes settings in the OSD. Quick Menu – For Horizontal Keystone.	24



ITEM	LABEL	DESCRIPTION	SEE PAGE:
17.	AUTO	Optimizes image size, position, and resolution.	
18.		Navigates and changes settings in the OSD. Quick Menu – For Vertical Keystone.	24
19.	SOURCE	Enter the Source menu.	
20.		Navigates and changes settings in the OSD. Quick Menu – For Horizontal Keystone.	24
21.	12V TRIGGER	When connected to the screen through a commercially available cable, the screen deploys automatically on start up of the projector. The screen retracts when the projector is powered off (see notes below).	
22.	WIRE REMOTE IN / OUT	Connect the wire remote from remote control to the projector for wire remote control. Connect "WIRE REMOTE OUT" to another projector (same model) "WIRE REMOTE IN" for serial control.	
23.	AUDIO IN	Connect an AUDIO cable from the audio device.	
24.	AUDIO OUT L/R	Connect an AUDIO cable for audio loop through.	
25.	AUDIO IN L/R	Connect the audio cables from an audio device for VIDEO audio input.	
26.	VIDEO	Connect the composite cable from a video device.	
27.	BNC	Connect a BNC cable from a computer.	
28.	AC IN	Connect the POWER cable.	
29.	RJ45	Connect a LAN cable from Ethernet.	
30.	USB POWER (5V/1.5A)	Connect a USB cable for USB host. <b>Note:</b> Support 5V/1.5A output as long as the projector Power On.	

**Note:**

- To use this feature, you must plug in the connector before turn on/off the projector.
- Screen controllers are supplied and supported by screen manufacturers.
- Do not use this jack for anything other than intended use.



**Warning:**

As a safety precaution, disconnect all power to the projector and connecting devices before making connections.

Bottom view

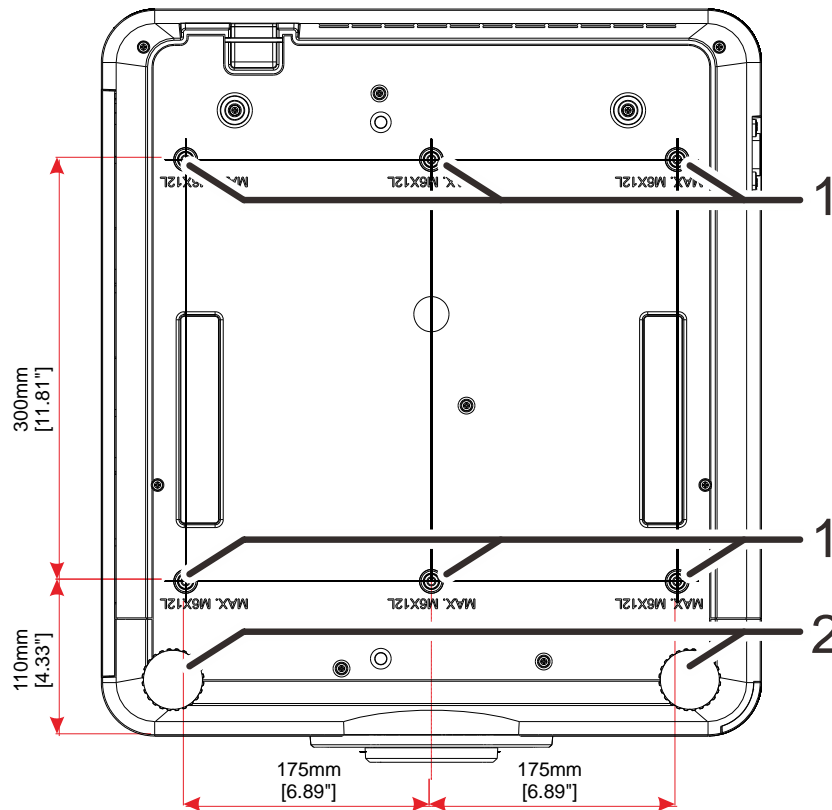

ITEM	LABEL	DESCRIPTION	SEE PAGE:
1.	Ceiling Mount Holes	Contact your dealer for information on mounting the projector on a ceiling.	
2.	Tilt Adjustor	Rotate adjuster lever to adjust angle position.	19

**Note:**

When installing, ensure that you use only UL Listed ceiling mounts.  
 For ceiling installations, use approved mounting hardware and M6 screws with a maximum screw depth of 12mm (0.47 inch).  
 The construction of the ceiling mount must be of a suitable shape and strength. The ceiling mount load capacity must exceed the weight of the installed equipment, and as an additional precaution be capable of withstanding three times the weight of the equipment over a period of 60 seconds.

## Reference drawings for stand

Please hire an installation service provider (for a fee) for the design and manufacture of a customized stand to be used for portrait projection. Please ensure that the design complies with the following conditions:

- Use the 6 screw holes at the back of the projector to secure it to the stand.  
Screw hole center dimension: 300 × 350 (pitch = 175) mm  
Screw hole dimension on the projector: M6 with the maximum depth 12 mm
- Horizontal adjustment mechanism (for example, bolts and nuts in 4 places)
- Please design the stand so that it does not easily topple over.

The drawing showing the dimensional requirements is not an actual stand design drawing.

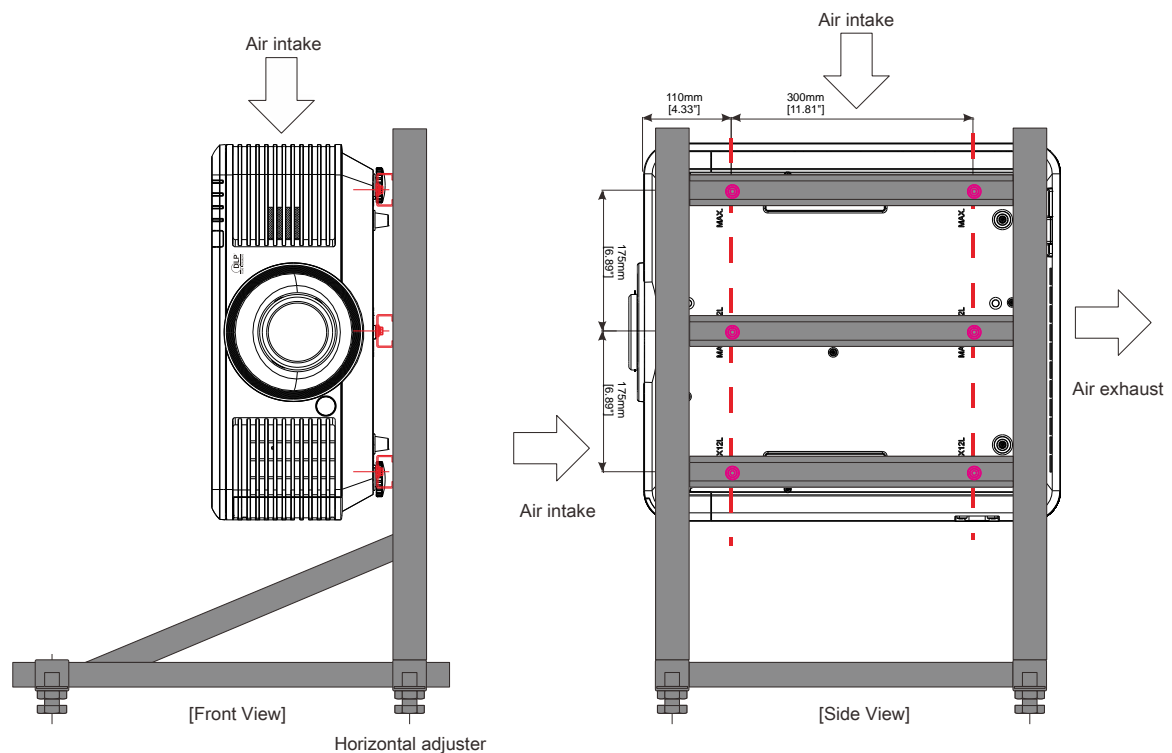

## Remote Control Parts

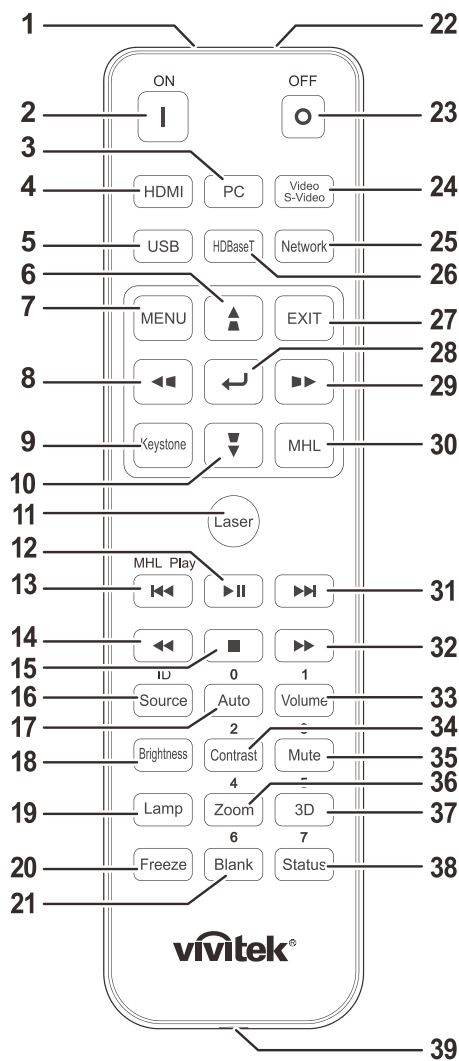

**Important:**

1. Avoid using the projector with bright fluorescent lighting turned on. Certain high-frequency fluorescent lights can disrupt remote control operation.
2. Be sure nothing obstructs the path between the remote control and the projector. If the path between the remote control and the projector is obstructed, you can bounce the signal off certain reflective surfaces such as projector screens.
3. The buttons and keys on the projector have the same functions as the corresponding buttons on the remote control. This user's manual describes the functions based on the remote control.

**Note:**

Complies with FDA performance standards for laser products except for deviations pursuant to Laser Notice No. 50, dated June 24, 2007



**Caution:**

Use of controls, adjustments or performance of procedures other than those specified herein may result in hazardous laser light exposure.

ITEM	LABEL	DESCRIPTION	SEE PAGE:
1.	IR Transmitter	Transmits signals to projector.	
2.	Power On	Turns the projector on.	15
3.	PC	Displays the PC source selection.	
4.	HDMI	Displays the HDMI1/HDMI 2/DVI source selection (toggle).	
5.	USB	NA	
6.	▲ ▲	Navigates and changes settings in the OSD. Quick Menu – For Vertical Keystone.	24
7.	MENU	Opens the OSD.	24
8.	◀◀	Navigates and changes settings in the OSD. Quick Menu – For Horizontal Keystone.	24
9.	Keystone	Opens the Keystone menu.	
10.	▼ ▼	Navigates and changes settings in the OSD. Quick Menu – For Vertical Keystone.	24
11.	Laser	Press to operate the on-screen pointer. <b>DO NOT POINT IN EYES.</b>	
12.	▶	Play or pause video/music for MHL.	
13.	◀◀	Reverse in set increments for MHL.	
14.	◀◀	Play the previous item on the programming list for MHL.	
15.	■	Stop video/music playing for MHL.	
16.	Source/ID	Alternate input source. Combo key function for Remote Control customer code settings (Press ID button + Number for 3 seconds).	24
17.	Auto/0	Auto adjustment for frequency, phase, and position. Number for Remote ID setting used.	24
18.	Brightness	Displays the brightness setting bar.	
19.	Lamp	Displays the light source selections.	
20.	Freeze	Freezes/unfreezes the on-screen picture.	
21.	Blank/6	Makes the screen blank. Number for Remote ID setting used.	
22.	Laser	Use as on-screen pointer. <b>DO NOT POINT IN EYES.</b>	
23.	Power Off	Turns the projector off.	15
24.	Video/S-Video	Displays the Video source selection.	
25.	Network	Open the OSD Network menu.	
26.	HDBaseT	Displays the HDBaseT source selection.	
27.	EXIT	Return to last OSD page.	
28.	↵	Enters and confirms settings in the OSD.	24
29.	▶▶	Navigates and changes settings in the OSD. Quick Menu – For Horizontal Keystone.	24
30.	MHL	Enable the Mobile High-Definition Link technology feature for smart devices.	
31.	▶▶	Forward in set increments for MHL.	
32.	▶▶	Play the following item on the programming list for MHL.	

ITEM	LABEL	DESCRIPTION	SEE PAGE:
33.	Volume/1	Displays the Volume setting bar. Number for Remote ID setting used.	
34.	Contrast/2	Displays the Contrast settings bar. Number for Remote ID setting used.	
35.	Mute/3	Mutes the built-in speaker. Number for Remote ID setting used.	
36.	Zoom/4	Displays the digital zoom settings bar. Number for Remote ID setting used.	22
37.	3D/5	Open the OSD 3D Setting menu. Number for Remote ID setting used.	
38.	Status/7	Opens the OSD Status menu (the menu only opens when an input device is detected). Number for Remote ID setting used.	
39.	Wired Jack	Connect wire remote to the projector.	

**Note:**

*Remote Combo Key Settings:*

*ID+0: Reset Remote Control customer code to default settings.*

*ID+1: Set Remote Control customer code to "1".*

*~*

*ID+7: Set Remote Control customer code to "7".*

*Projector also need setting ID for unique control. Projector ID settings see page 42.*

**Note:**

*When the projector is under **MHL** mode, The keypad on projector should be with the same definition of the key on remote control.*

*When **MHL** function:*

***MENU** for App settings, ▲ **Up**, ▼ **Down**, ◀ **Left** and ▶ **Right** are used as directional arrows, also included **ENTER** and **EXIT**.*

**Controlling your smart device with the remote control:**

*When the projector projects the contents from your **MHL** compatible smart device, you can use the remote control to control your smart device.*

*To enter the **MHL** mode, the following buttons are available for controlling your smart device, Arrow keys (▲ **Up**, ▼ **Down**, ◀ **Left**, ▶ **Right**), **MENU**, **EXIT**, **MHL** control buttons.*

## **Remote Control Operating Range**

The remote control uses infrared transmission to control the projector. It is not necessary to point the remote directly at the projector. Provided you are not holding the remote perpendicular to the sides or the rear of the projector, the remote will function well within a radius of about 7 meters (23 feet) and 15 degrees above or below the projector level. If the projector does not respond to the remote control, move a little closer.

## **Projector and Remote Control Buttons**

The projector can be operated using the remote control or the buttons on the top of the projector. All operations can be carried out with the remote control; however, the buttons on the projector are limited in use.

## Inserting the Remote Control Batteries

1. Remove the battery compartment cover by sliding the cover in the direction of the arrow.

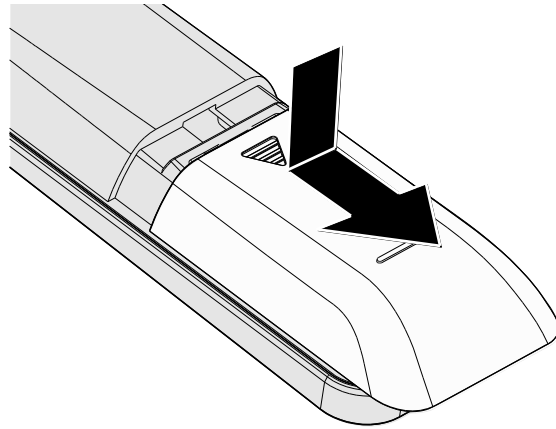

2. Insert the battery with the positive side facing up.

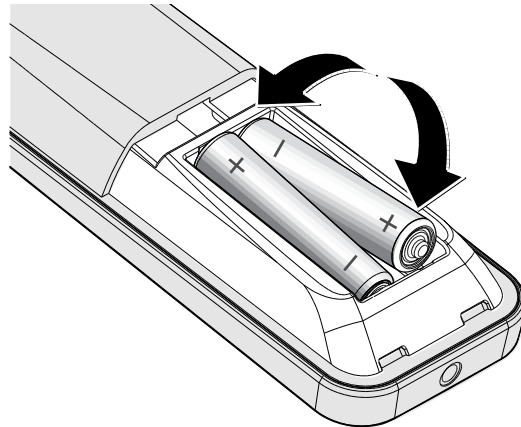

3. Replace the cover.

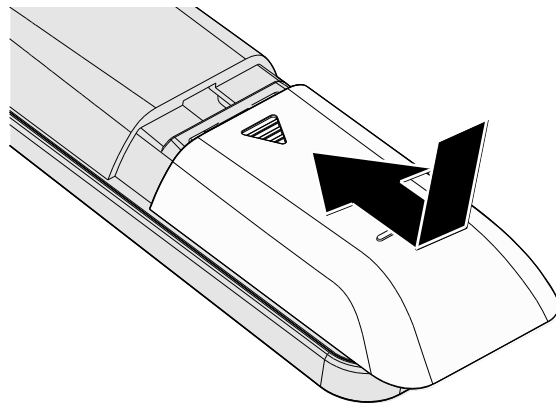

**Caution:**

1. Only use AAA batteries (Alkaline batteries are recommended).
2. Dispose of used batteries according to local ordinance regulations.
3. Remove the batteries when not using the projector for prolonged periods.



## Installing or Removing the Optional Lens



### Caution:

- Do not shake or place excessive pressure on the projector or the lens components as the projector and lens components contain precision parts.
- Before removing or installing the lens, be sure to turn off the projector, wait until the cooling fans stop, and turn off the main power switch.
- Do not touch the lens surface when removing or installing the lens.
- Keep fingerprints, dust or oil off the lens surface.
- Do not scratch the lens surface.
- Work on a level surface with a soft cloth under it to avoid scratching.
- If you remove and store the lens, attach the lens cap to the projector to keep off dust and dirt.

### Installing the New Lens

Remove both end caps from the lens.

Removal of the Anti-dust cap before inserting a lens for the first time.

1. Align the flange and correctly position at the 11 o'clock position as shown in the picture.

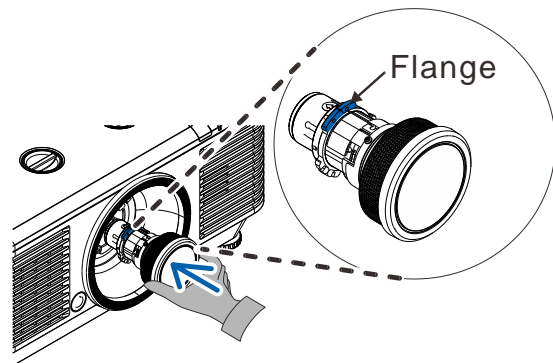

2. Rotate the lens clockwise until you feel it click into place.

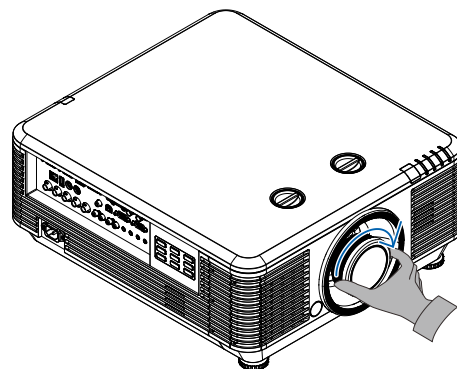

### Removing the Existing Lens From the Projector

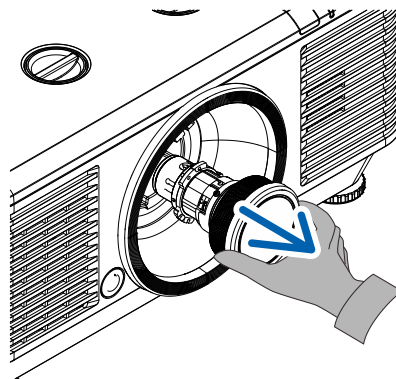
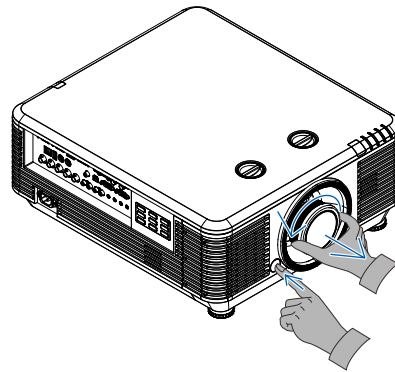

- 1.** Push the LENS RELEASE button to the unlock position.
- 2.** Grasp the lens.
- 3.** Rotate the lens counterclockwise. The existing lens will be disengaged.
- 4.** Pull out the existing lens slowly.

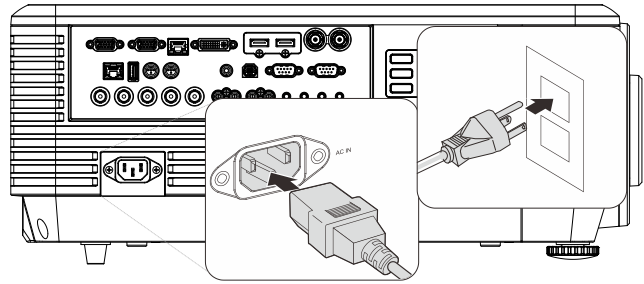

## Starting and Shutting down the Projector

1. Securely connect the power cord and signal cable. When connected, the power led will flash green to solid green.



2. Turn on the light source by pressing “” button on the projector or “” on the remote control. The PWR LED will now flash green. The startup screen will display in approximately 30 seconds. The first time you use the projector, you can select your preferred language from quick menu after the startup screen display. (See [Setting the OSD Language](#) on page 25)

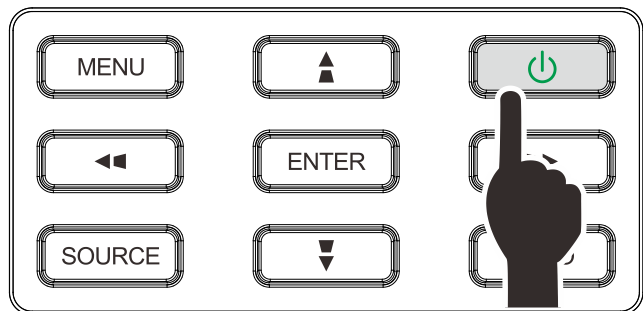

See [Setting an Access Password \(Security Lock\)](#) on page 17 if security lock is enabled.



3. If more than one input device is connected, press the **SOURCE** button and use ▲▼ to scroll among devices.

(Component is supported through the RGB to Component adapter.)



- HDMI 1: High-Definition Multimedia Interface compatible
- HDMI 2 / MHL: High-Definition Multimedia Interface and Mobile High-Definition Link compatible
- DVI: DVI
- VGA 1: Analog RGB  
DVD input YCbCr/ YPbPr, or HDTV input YPbPr via D-sub connector
- BNC: Analog RGB
- Composite Video: Traditional composite video
- HDBaseT: Digital Video through the HDBaseT transmitter

Note:

It is recommended to use a certified TX box (VIDEO EXTENDER) – Rexton (EVBMN-110L38) for the HDBaseT function and there is no guarantee of full response when other brands of TX box are used. Using a single HDBaseT CAT5e cable, the projector supports an HDBaseT connection distances to 100m/328ft.

4. When the “Power Off? /Press **Power** again” message appears, press the **POWER** button. The projector turns off.

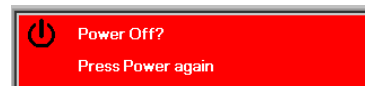

**Caution:**

Do not unplug the power cord until the **POWER LED** stops flashing – indicating the projector has cooled down.

## Setting an Access Password (Security Lock)

You can use the four (arrow) buttons to set a password and prevent unauthorized use of the projector.

When enabled, the password must be entered after you power on the projector. (See [Navigating the OSD](#) on page 24 and [Setting the OSD Language](#) on page 25 for help on using OSD menus.)



### **Important:**

Keep the password in a safe place. Without the password, you will not be able to use the projector. If you lose the password, contact your reseller for information on clearing the password.

1. Press the **MENU** button to open the OSD menu.

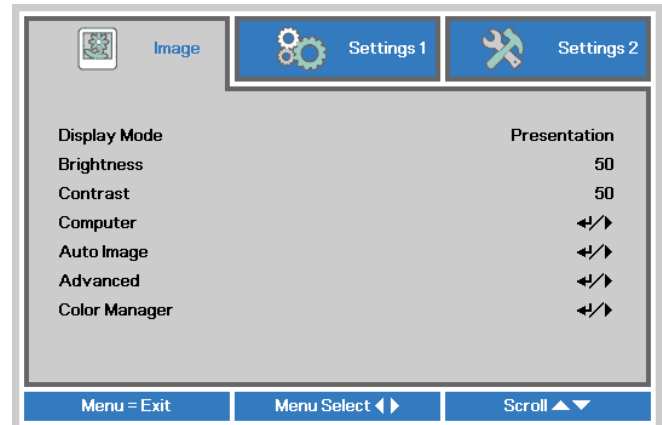

2. Press the cursor **◀▶** button to move to the **Settings 1** menu, press the cursor **▲▼** button to select **Advanced 1**.

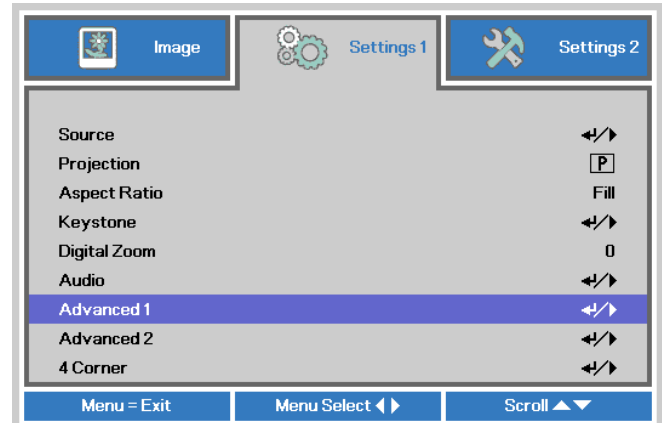

3. Press **↵** (Enter) / **▶** to enter the **Advanced 1** sub menu. Press the cursor **▲▼** button to select **Security Lock**.



4. Press the cursor **◀▶** button to enter and enable or disable security lock function.

A password dialog box automatically appears.

5. You can use the cursor buttons ▲▼◀▶ either on keypad or IR remote control for password entry. You can use any combination including the same arrow five times, but not less than five.

Press the cursor buttons in any order to set the password. Push the **MENU** button to exit the dialog box.

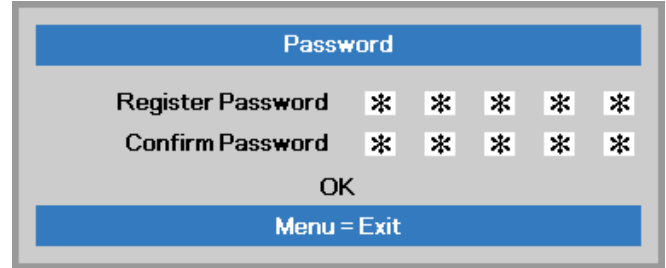
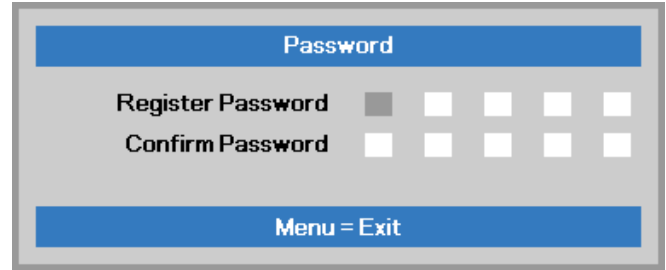

6. The password confirm menu appears when user presses the power-on key in case the **Security Lock** is enabled. Enter the password in the order you set it at step 5. In case you forget the password, please contact the service center. The service center will validate the owner and help reset the password.

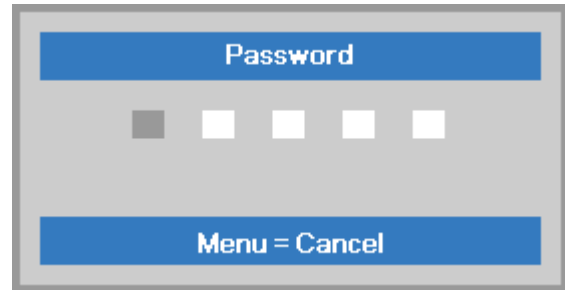

## Adjusting the Projector Level

Take note of the following when setting up the projector:

- *The projector table or stand should be level and sturdy.*
- *Position the projector so that it is perpendicular to the screen.*
- *Ensure the cables are in a safe location. You could trip over them.*

1. To raise the level of the projector, twist the adjusters counter clockwise.

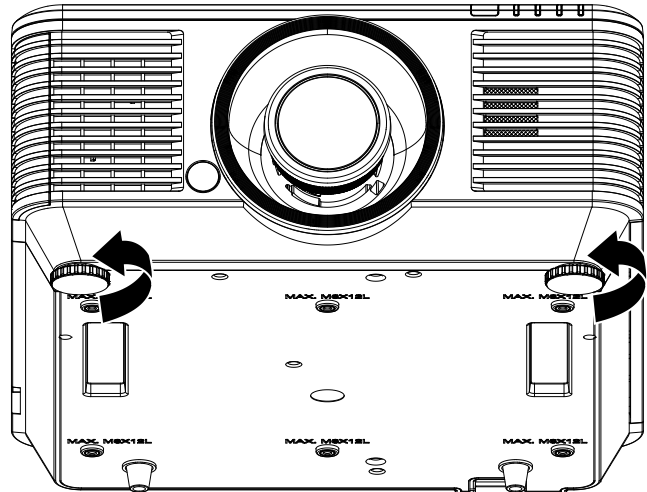

2. To lower the level of the projector, lift the projector and twist the adjusters clockwise.

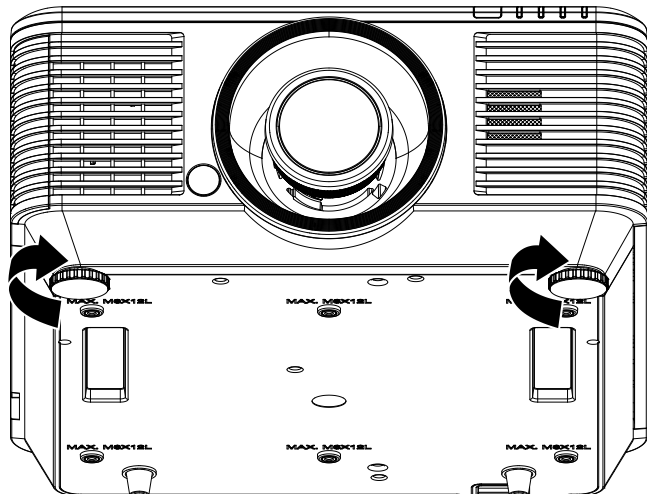

## Adjusting Projected Image Position Using Lens Shift

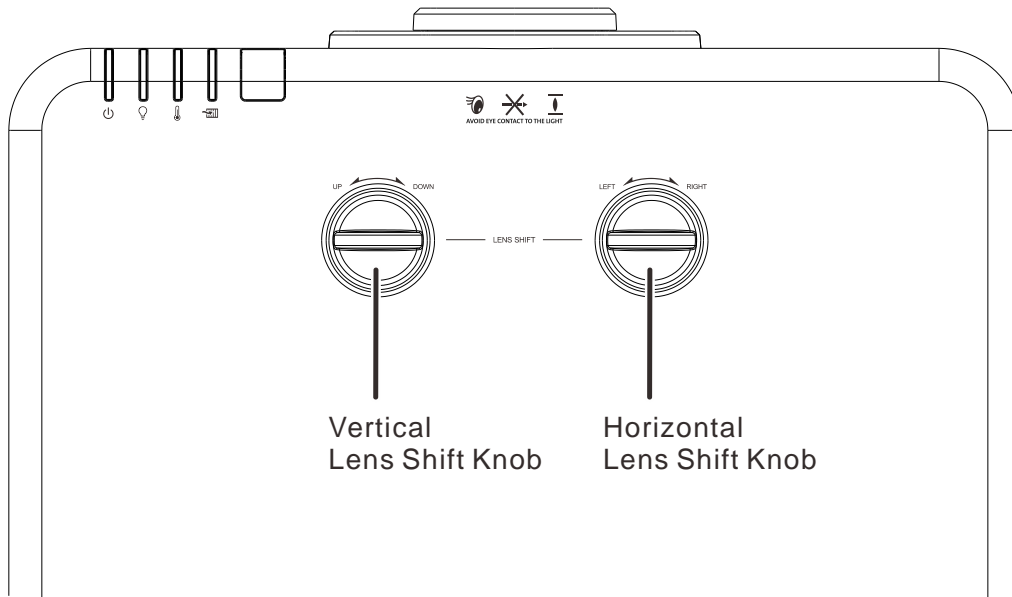

The Lens Shift feature provides a lens shift function that can be used to adjust the position of the projected image either horizontally or vertically within the range detailed below.

Shift is a unique system that provides lens shift while maintaining a much higher ANSI contrast ratio than traditional lens shift systems.

**Note:**

*Do not rotate lens shift knob further under click sound and lightly press the knob to rotate back.*

### Adjusting the vertical image position

The vertical image height can be adjusted between 55% and -15% of offset position. Note that the maximum vertical image height adjustment can be limited by the horizontal image position. For example it is not possible to achieve the maximum vertical image position height detailed above if the horizontal image position is at maximum. Please consult the Shift Range diagram below for further clarification.

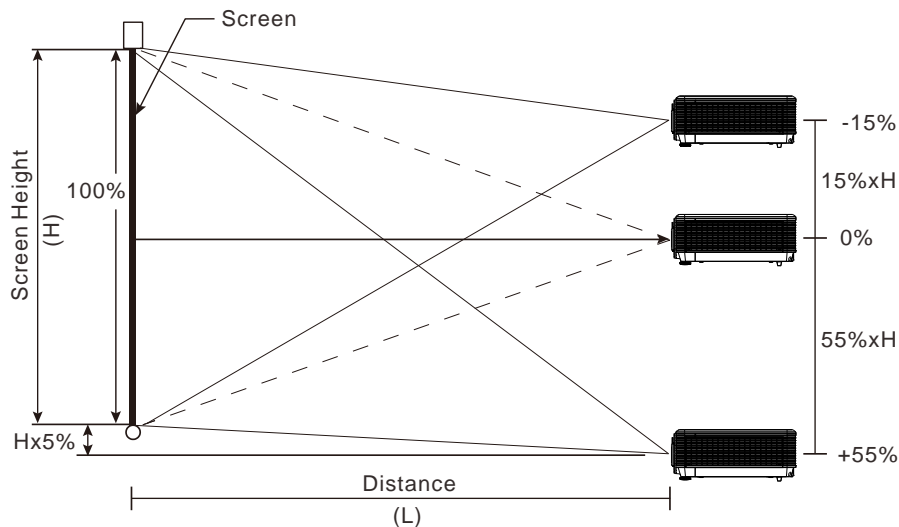



### Adjusting the horizontal image position

With the lens in the center position the horizontal image position can be adjusted to the left or right by up to a maximum of 5% of the image width. Note that the maximum horizontal image height adjustment can be limited by the vertical image position. For example it is not possible to achieve the maximum horizontal image position if the vertical image position is at maximum. Please consult the Shift Range diagram below for further clarification.

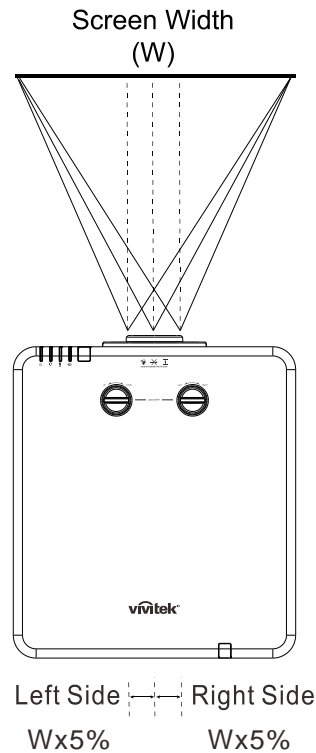

### Shift Range Diagram

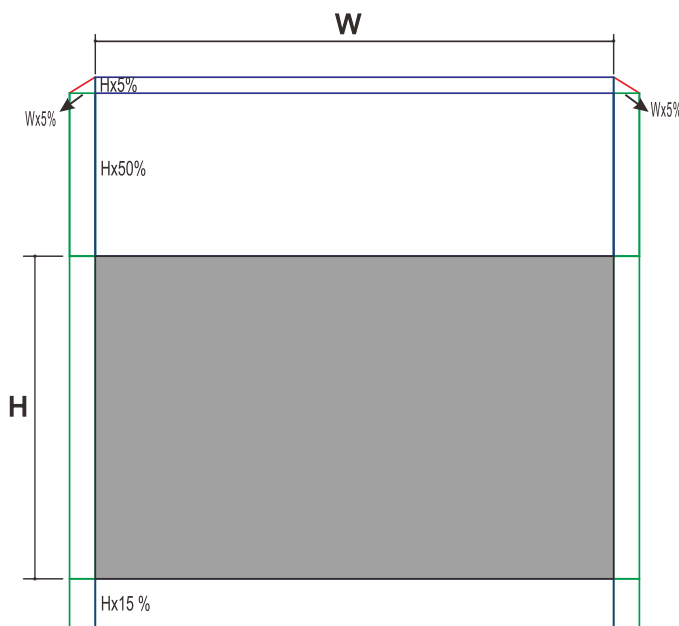

When W and H at 0% offset position  
 The max. H up shift=Hx55%  
 The max. H down shift=Hx15%  
 The max. W shift=Wx5%  
 When max. W shift is Wx5%  
 max. H shift=Hx50%  
 When max. H shift is Hx55%  
 max. W shift=Hx0%

## Adjusting the Zoom, Focus and Keystone

1. Use the **Image-zoom** control (on the projector only) to resize the projected image and screen size. **B**
2. Use the **Image-focus** control (on the projector only) to sharpen the projected image. **A**

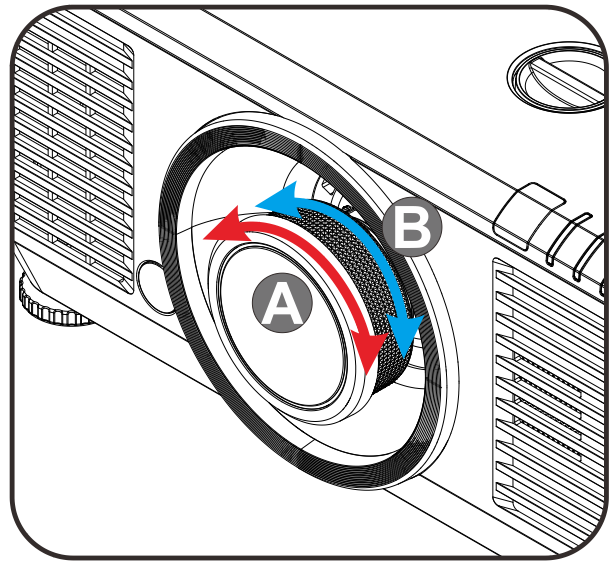

3. Press the / / / buttons (on the projector or the remote control) to correct vertical or horizontal image-trapezoid or press the **Keystone** button (on the remote) to selected V (Vertical) or H (Horizontal) keystone.

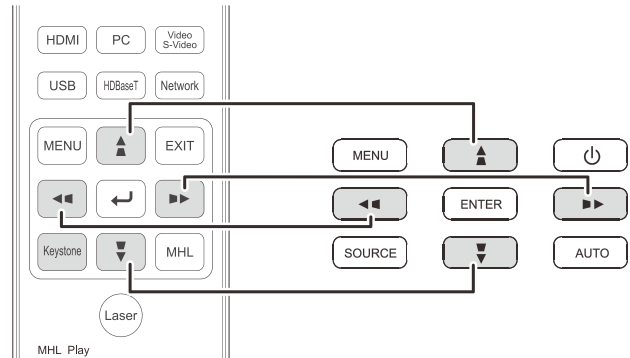

Remote control and OSD panel

4. The keystone control appears on the display.  
 Press / for V Keystone correcting image.  
 Press / for H Keystone correcting image.

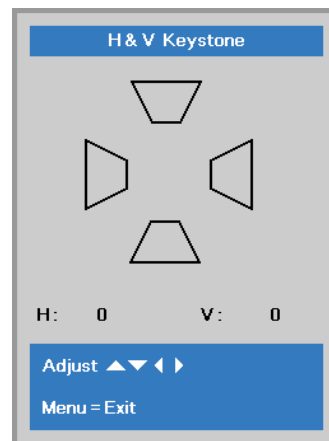

## Adjusting the Volume

1. Press the **Volume** buttons on the remote control.

The volume control appears on the display.

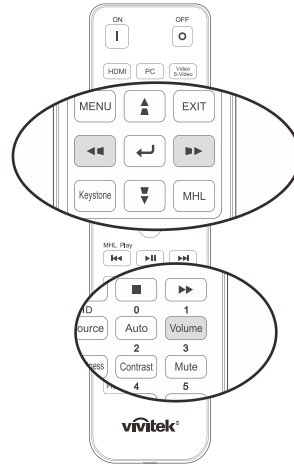

2. Press the ◀ / ▶ buttons on the keypad to adjust **Volume +/-**.



3. Press the **MUTE** button to turn off the volume (This feature is available only on the remote).

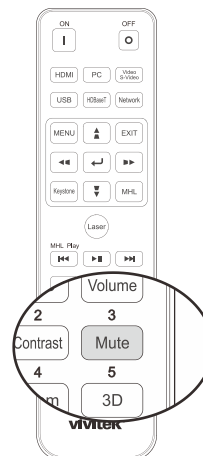

## ON-SCREEN DISPLAY (OSD) MENU SETTINGS

### OSD Menu Controls

The projector has an OSD that lets you make image adjustments and change various settings.

### Navigating the OSD

You can use the remote control cursor buttons or the buttons on the projector to navigate and make changes to the OSD. The following illustration shows the corresponding buttons on the projector.

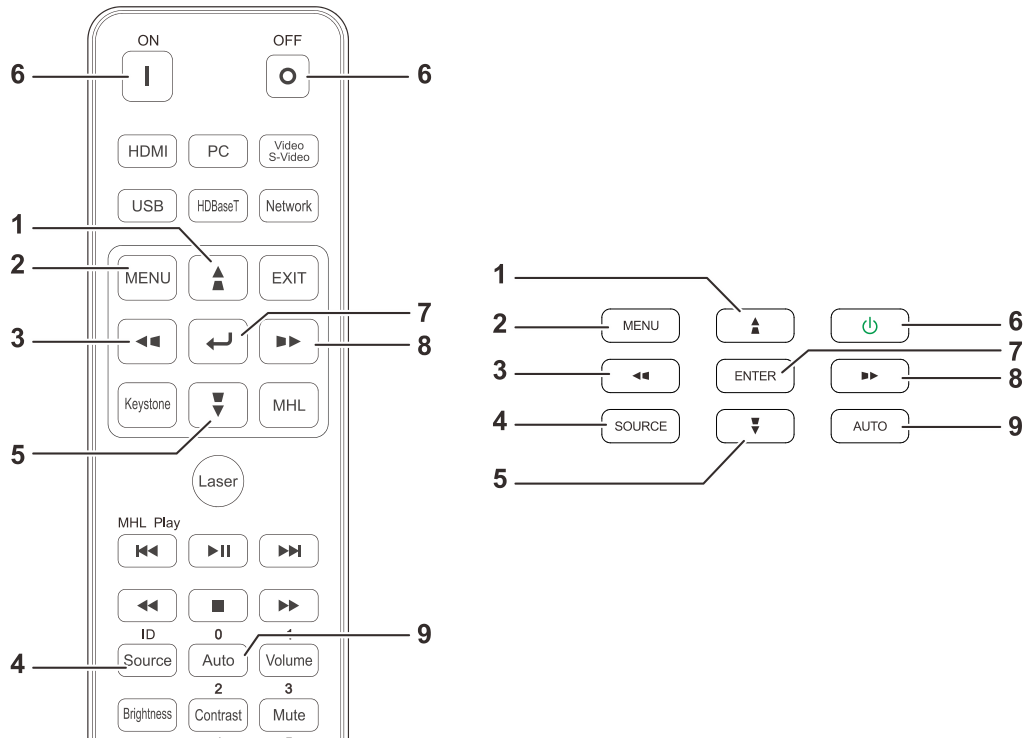

1. To enter the OSD, press the **MENU** button.
2. There are three menus. Press the cursor ◀ / ▶ buttons to move through the menus.
3. Press the cursor ▲ / ▼ buttons to move up and down in a menu.
4. Press the cursor ◀ / ▶ buttons to change values for settings.
5. Press the **MENU** button to close the OSD or leave a submenu. Press the **EXIT** button to return to the previous menu.

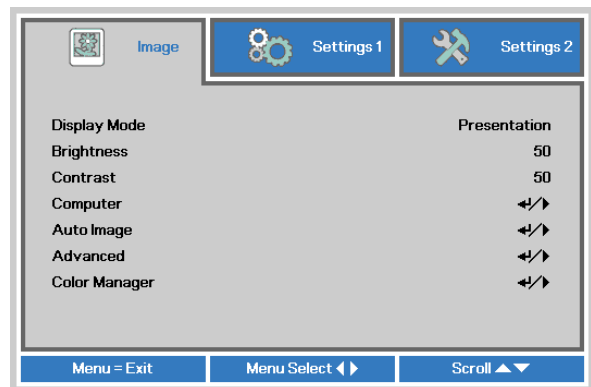

**Note:**

Depending on the video source, not all items in the OSD are available. For example, the **Horizontal/Vertical Position** items in the **Computer** menu can only be modified when connected to a PC. Items that are not available cannot be accessed and are grayed out.

## Setting the OSD Language

Set the OSD language to your preference before continuing.

1. Press the **MENU** button. Press the cursor ◀▶ button to navigate to **Settings 1**. Press the cursor ▲▼ button to move to the **Advanced 1** menu.

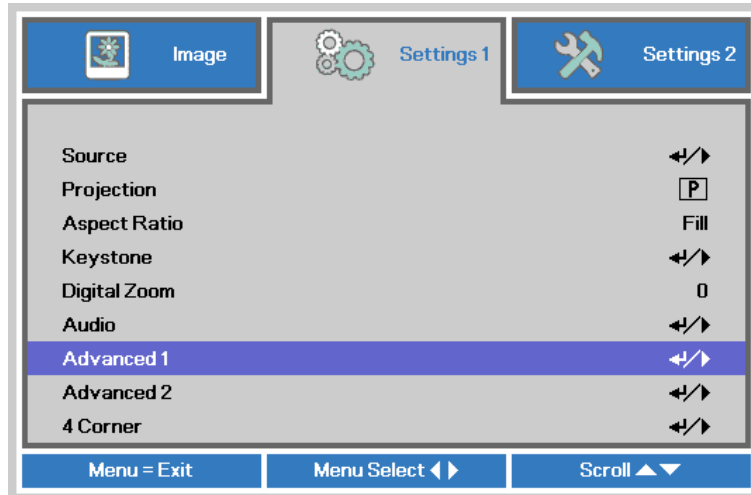

2. Press ◀ (Enter) / ▶ to enter the **Advanced 1** sub menu. Press the cursor ▲▼ button until **Language** is highlighted.



3. Press the cursor button until the language you want is highlighted.
4. Press the MENU button four times to close the OSD.

## OSD Menu Overview

Use the following illustration to quickly find a setting or determine the range for a setting.

Main Menu	Sub Menu	Settings		
Image	Display Mode	Presentation, Bright, Game, Movie, Vivid, TV, sRGB, DICOM SIM, User, User2		
	Brightness	0~100		
	Contrast	0~100		
	Computer	Horizontal Position	-5~5 (depend on Auto Sync)	
		Vertical Position	-5~5 (depend on Auto Sync)	
		Frequency	0~31	
		Tracking	-5~5	
		Auto Sync	On, Off	
	Auto Image			
	Advanced	Brilliant Color	0~10	
		Sharpness	0~31	
		Gamma	1.8, 2.0, 2.2, 2.4, B&W, Linear	
		Color Temperature	Warm, Normal, Cold	
		Video AGC	Off, On	
		Video Saturation	0~100	
		Video Tint	0~100	
		White Balance	R Gain	0~200
			G Gain	0~200
			B Gain	0~200
			R Offset	-100~100
	G Offset		-100~100	
B Offset	-100~100			
Color Manager	Red	Hue, Saturation, Gain 0~100		
	Green	Hue, Saturation, Gain 0~100		
	Blue	Hue, Saturation, Gain 0~100		
	Cyan	Hue, Saturation, Gain 0~100		
	Magenta	Hue, Saturation, Gain 0~100		
	Yellow	Hue, Saturation, Gain 0~100		
	White	Red, Green, Blue 0~100		

Main Menu	Sub Menu	Settings		
Settings 1	Source	reference Input Source Select (IR/Keypad)		
	Projection	Normal, Real, Ceiling, Real+Ceiling		
	Aspect Ratio	Fill, 4:3, 16:9, Letter Box, Native, 2.35:1		
	Keystone	H: -25 ~ +25 V: -30 ~ +30		
	Digital Zoom	-10~10		
	Audio	Volume	0~10	
		Mute	Off, On	
		Internal Speaker	Off, On	
	Advanced 1	Language	English, Français, Deutsch, Español, Português, 簡體中文, 繁體中文, Italiano, Norsk, Svenska, Nederlands, Русский, Polski, Suomi, Ελληνικά, 한국어, Magyar, Čeština, العربية, Türkçe, Việt, 日本語, ไทย, فارسی, עברית, Dansk, Fran. Can.	
		Security Lock	Off, On	
		Blank Screen	Blank, Red, Green, Blue, White	
		Splash Logo	Std., Black, Blue	
		Closed Captioning	Off, On	
		Keypad Lock	Off, On	
		3D Setting	3D	Off, DLP-Link, IR
			3D Sync Invert	Off, On
			3D Format	Frame Sequential, Top/Bottom, Side-By-Side, Frame Packing (3D Frame Packing HDMI source only)
			3D Sync Out delay	0~359
	3D Sync Input		Off, On	
	Advanced 2	Test Pattern	None, RGB Ramps, Color Bars, Step Bars, CheckBoard, Grid, Horizontal lines	
		H Image Shift	-50~50	
		V Image Shift	-50~50	
	4 Corner	Left-Top, Right-Top, Right-Bottom, Left-Bottom		

Main Menu	Sub Menu	Settings		
Settings 2	Auto Source	Off, On		
	No Signal Power Off	0~180		
	Auto Power On	Off, On		
	Light Mode	Normal, Eco, Eco Plus, Dimming, Extreme Dimming, Custom Light		
	Reset All			
	Status	Active Source		
		Video Information		
		Light Hours		
		Software Version		
		Remote ID		
		Serial Number		
		Air Filter Hour		
		Advanced 1	Menu Position	Center, Down, Up, Left, Right
			Translucent Menu	0%, 25%, 50%, 75%, 100%
			Low Power Mode	On, On By Lan
	Fan Speed		Normal, High	
	Light Info		Normal, Eco, Eco Plus, Dimming, Extreme Dimming	
	Projector ID		0~98	
	Remote ID		Default, 1, 2, 3, 4, 5, 6, 7	
	Network		Network State	Connect, Disconnect
			DHCP	On, Off
			IP Address	0~255, 0~255, 0~255. 0~255
			Subnet Mask	0~255, 0~255, 0~255. 0~255
			Gateway	0~255, 0~255, 0~255. 0~255
			DNS	0~255, 0~255, 0~255. 0~255
Apply			Ok / Cancel	
HDBaseT Setting	HDBaseT-IR/RS232		Off, On	
	Front IR	On, Off		
	Rear IR	On, Off		
Advanced 2	Sleep Timer	0~600		
	Source Filter	HDMI1	Disable, Enable	
		HDMI2/MHL	Disable, Enable	
		DVI	Disable, Enable	
		VGA1	Disable, Enable	
		BNC	Disable, Enable	
		Composite Video	Disable, Enable	
		HDBaseT	Disable, Enable	
	Air Filter Timer Reset	OK / Cancel		
	Custom Light	25~100		



## Image Menu



### Attention !

All of display mode parameters when changed will be saved to user mode.

Press the **MENU** button to open the **OSD** menu. Press the cursor ◀▶ button to move to the **Image Menu**. Press the cursor ▲▼ button to move up and down in the **Image menu**. Press ◀▶ to enter and change values for settings.

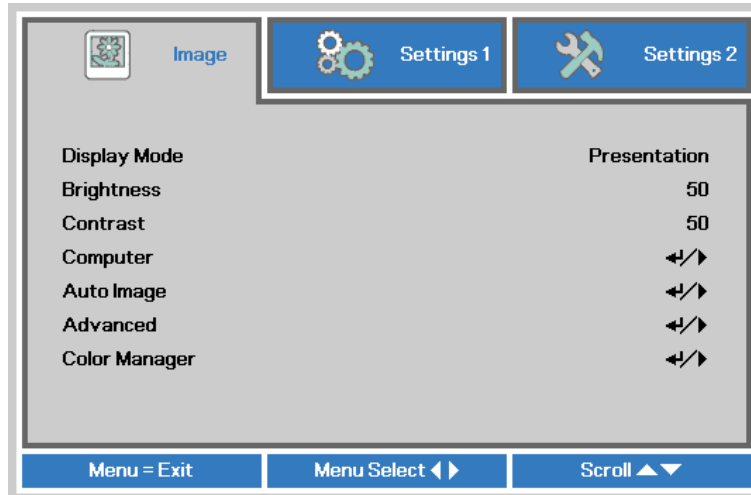

ITEM	DESCRIPTION
Display Mode	Press the cursor ◀▶ button to enter and set the Display Mode.
Brightness	Press the cursor ◀▶ button to enter and adjust the display brightness.
Contrast	Press the cursor ◀▶ button to enter and adjust the display contrast.
Computer	Press ◀ (Enter) / ▶ to enter the Computer menu. See <a href="#">Computer Menu</a> on page 30.
Auto Image	Press ◀ (Enter) / ▶ to automatically adjustment for phase, tracking, size and position.
Advanced	Press ◀ (Enter) / ▶ to enter the Advanced menu. See <a href="#">Advanced Feature</a> on page 31.
Color Manager	Press ◀ (Enter) / ▶ to enter the color manager menu. See page 33 for more information on <a href="#">Color Manager</a>

## Computer Menu

Press the **MENU** button to open the **OSD** menu. Press ◀▶ to move to the **Image** menu. Press ▲▼ to move to the **Computer** menu and then press **Enter** or ▶. Press ▲▼ to move up and down in the **Computer** menu.

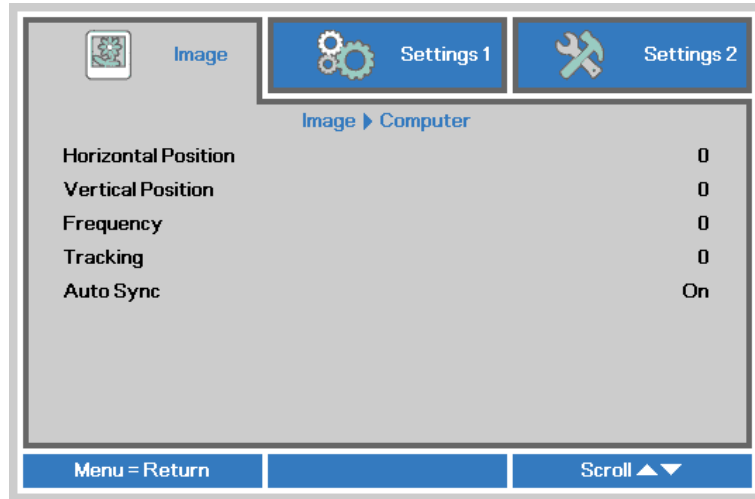

ITEM	DESCRIPTION
Horizontal Position	Press the cursor ◀▶ button to enter and adjust the display position to left or right.
Vertical Position	Press the cursor ◀▶ button to enter and adjust the display position to up or down.
Frequency	Press the cursor ◀▶ button to enter and adjust the A/D sampling clock.
Tracking	Press the cursor ◀▶ button to enter and adjust the A/D sampling dot.
Auto Sync	Press the cursor ◀▶ button to enter and adjust the Auto Sync Position to On or Off.

## Advanced Feature

Press the **Menu** button to open the **OSD** menu. Press ◀▶ to move to the **Image** menu. Press ▼▲ to move to the **Advanced** menu and then press **Enter** or ▶. Press ▼▲ to move up and down in the **Advanced** menu.

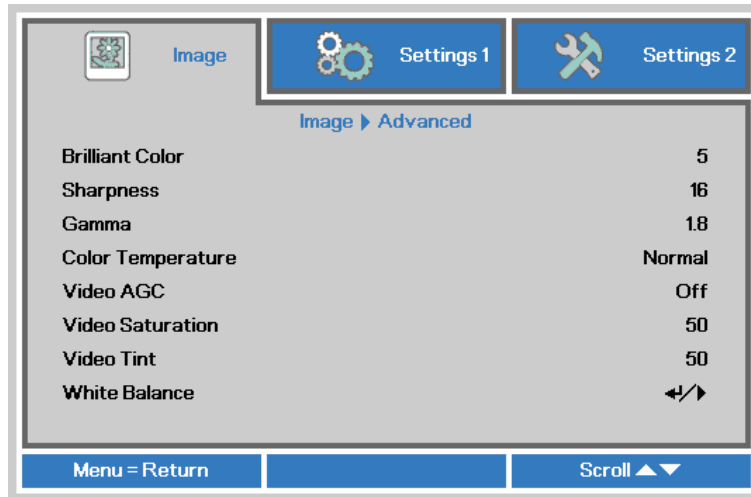

ITEM	DESCRIPTION
Brilliant Color	Press the cursor ◀▶ button to enter and adjust the Brilliant Color value.
Sharpness	Press the cursor ◀▶ button to enter and adjust the display sharpness.
Gamma	Press the cursor ◀▶ button to enter and adjust the gamma correction of the display.
Color Temperature	Press the cursor ◀▶ button to enter and adjust the color temperature.
Video AGC	Press the cursor ◀▶ button to enter and enable or disable the Automatic Gain Control for video source.
Video Saturation	Press the cursor ◀▶ button to enter and adjust the video saturation.
Video Tint	Press the cursor ◀▶ button to enter and adjust the video tint/hue.
White Balance	Press the <b>ENTER</b> / ▶ button to enter the <b>White Balance</b> sub menu. See <a href="#">White Balance</a> on page 32

## White Balance

Press the **ENTER** button to enter the **White Balance** sub menu.

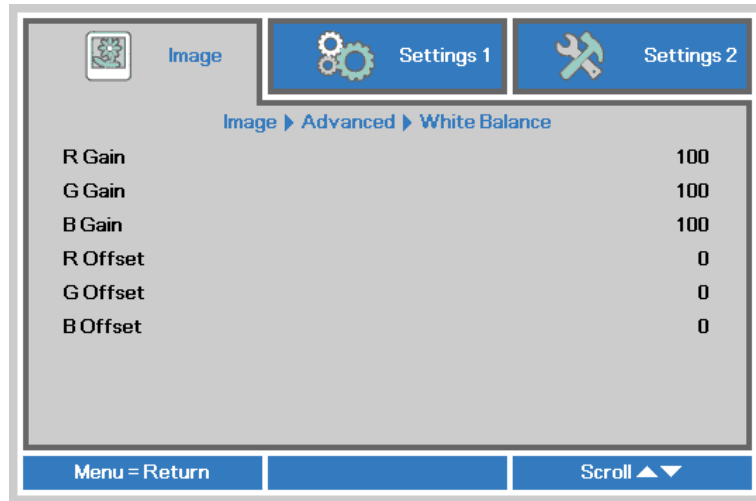

ITEM	DESCRIPTION
R Gain	Press the ◀▶ buttons to adjust the Red Gain.
G Gain	Press the ◀▶ buttons to adjust the Green Gain.
B Gain	Press the ◀▶ buttons to adjust the Blue Gain.
R Offset	Press the ◀▶ buttons to adjust the Red Offset.
G Offset	Press the ◀▶ buttons to adjust the Green Offset.
B Offset	Press the ◀▶ buttons to adjust the Blue Offset.

## Color Manager

Press the **Menu** button to open the **OSD** menu. Press ◀▶ to move to the **Image** menu. Press ▼▲ to move to the **Color Manager** menu and then press **Enter** or ▶. Press ▼▲ to move up and down in the **Color Manager** menu.

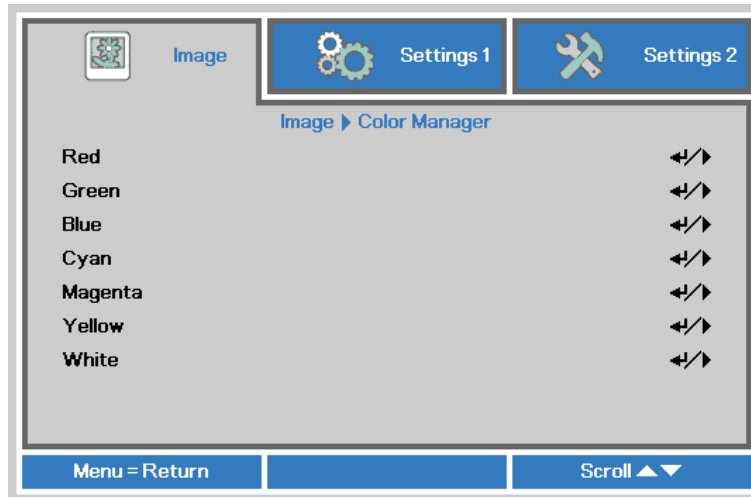

ITEM	DESCRIPTION
Red	Select to enter the Red Color Manager. Press the ◀▶ buttons to adjust the Hue, Saturation, and Gain.
Green	Select to enter the Green Color Manager. Press the ◀▶ buttons to adjust the Hue, Saturation, and Gain.
Blue	Select to enter the Blue Color Manager. Press the ◀▶ buttons to adjust the Hue, Saturation, and Gain.
Cyan	Select to enter the Cyan Color Manager. Press the ◀▶ buttons to adjust the Hue, Saturation, and Gain.
Magenta	Select to enter the Magenta Color Manager. Press the ◀▶ buttons to adjust the Hue, Saturation, and Gain.
Yellow	Select to enter the Yellow Color Manager. Press the ◀▶ buttons to adjust the Hue, Saturation, and Gain.
White	Select to enter the White Color Manager. Press the ◀▶ buttons to adjust the Red, Green, and Blue.

## Settings 1 Menu

Press the **MENU** button to open the **OSD** menu. Press the cursor **◀▶** button to move to the **Settings 1** menu. Press the cursor **▲▼** button to move up and down in the **Settings 1** menu. Press **◀▶** to enter and change values for settings.



ITEM	DESCRIPTION
Source	Press the cursor <b>◀▶</b> button to enter the Source menu. Reference input Source select (IR / Keypad).
Projection	Press the cursor <b>◀▶</b> button to enter and choose from four projection methods.
Aspect Ratio	Press the cursor <b>◀▶</b> button to enter and adjust the video aspect ratio.
Keystone	Press <b>↵</b> (Enter) / <b>▶</b> to enter the keystone menu. See <a href="#">Keystone</a> on page 35.
Digital Zoom	Press the cursor <b>◀▶</b> button to enter and adjust the Digital Zoom menu.
Audio	Press <b>↵</b> (Enter) / <b>▶</b> to enter the Audio menu. See <a href="#">Audio</a> on page 35.
Advanced 1	Press <b>↵</b> (Enter) / <b>▶</b> to enter the Advanced 1 menu. See <a href="#">Advanced 1 Feature</a> on page 36.
Advanced 2	Press <b>↵</b> (Enter) / <b>▶</b> to enter the Advanced 2 menu. See <a href="#">Advanced 2 Feature</a> on page 38.
4 Corner	Press <b>↵</b> (Enter) / <b>▶</b> to enter the 4 Corner sub menu. See <a href="#">4 Corner</a> on page 39. <b>Note:</b> Without support when 3D mode activated.

## Keystone

Press the **Menu** button to open the **OSD** menu. Press ◀▶ to move to the **Settings 1** menu. Press ▼▲ to move to the **Keystone** menu and then press **Enter** or ▶. Press ▼▲ to adjust vertical values from -30 to 30. Press ◀▶ to adjust horizontal values from -25 to 25.

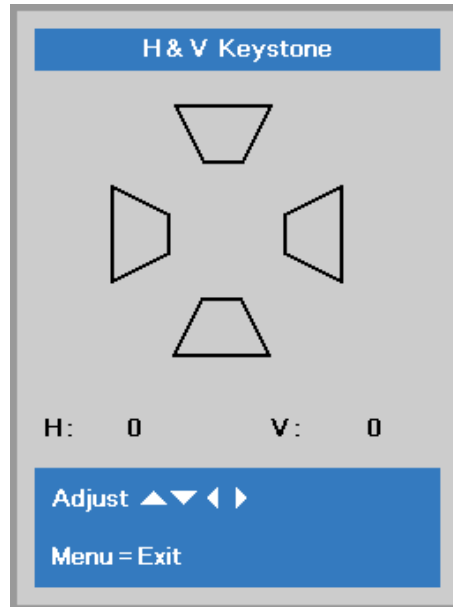

## Audio

Press the **Menu** button to open the **OSD** menu. Press ◀▶ to move to the **Settings 1** menu. Press ▼▲ to move to the **Audio** menu and then press **Enter** or ▶. Press ▼▲ to move up and down in the **Audio** menu.

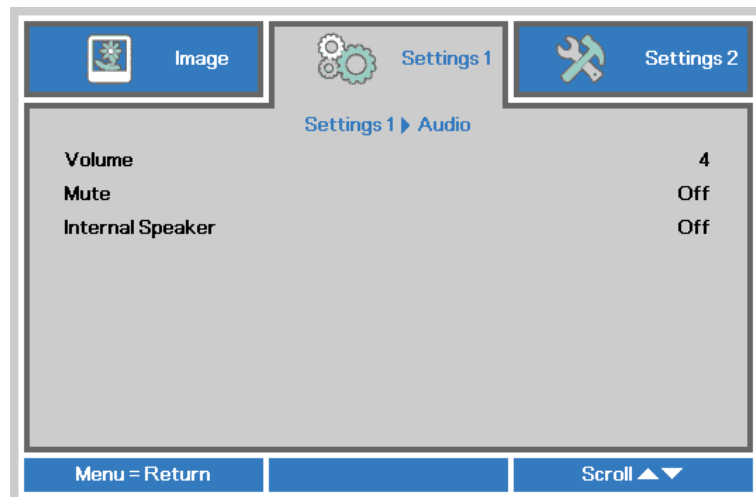

ITEM	DESCRIPTION
Volume	Press the cursor ◀▶ button to enter and adjust the audio volume.
Mute	Press the cursor ◀▶ button to enter and turn on or off the speaker.
Internal Speaker	Press the cursor ◀▶ button to select internal speaker output on or off.

### Advanced 1 Feature

Press the **Menu** button to open the **OSD** menu. Press ◀▶ to move to the **Settings 1** menu. Press ▲▼ to move to the **Advanced 1** menu and then press **Enter** or ▶. Press ▲▼ to move up and down in the **Advanced 1** menu. Press ◀▶ to enter and change values for setting.

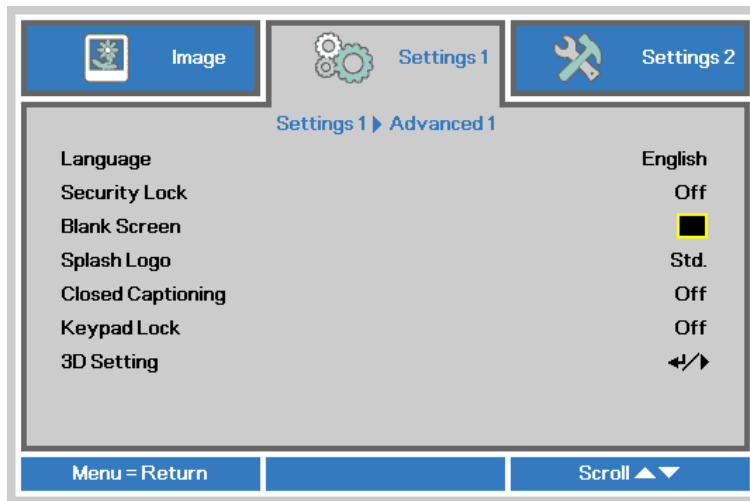

ITEM	DESCRIPTION
Language	Press the cursor ◀▶ button to enter and select a different localization Menu.
Security Lock	Press the cursor ◀▶ button to enter and enable or disable security lock function.
Blank Screen	Press the cursor ◀▶ button to enter and select different color to blank the screen.
Splash Logo	Press the cursor ◀▶ button to enter and enable or disable Splash Logo.
Closed Captioning	Press the cursor ◀▶ button to enter and enable or disable Closed Captioning
Keypad Lock	Press the cursor ◀▶ button to enter and enable or disable keys can be work on keypad. <b>Note</b> : Hold the cursor ▼ button on keypad for 5 seconds to unlock keypad
3D Setting	Press ◀ (Enter) / ▶ to enter the 3D menu. See page 37 for more information on <a href="#">3D Setting</a> .

**Note:**

To enjoy the 3D function, first enable the Play Movie in 3D setting found in your DVD device under the 3D Disc Menu.



## 3D Setting

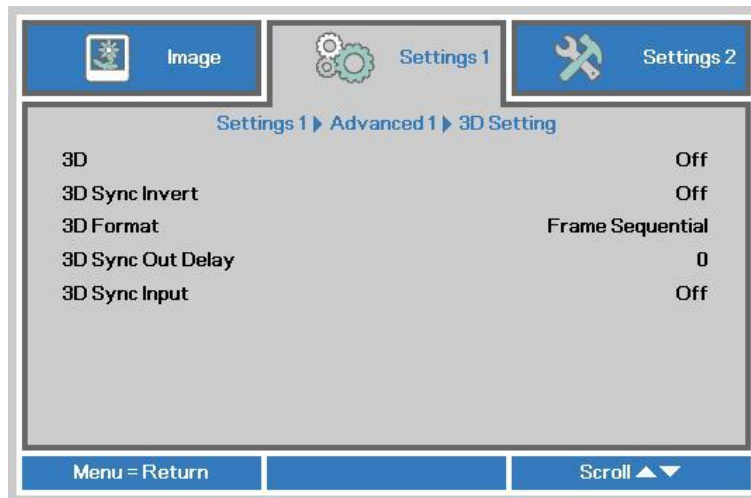

ITEM	DESCRIPTION
3D	Press the cursor ◀▶ button to enter and select different 3D mode.
3D Sync Invert	Press the cursor ◀▶ button to enter and enable or disable 3D Sync Invert.
3D Format	Press the cursor ◀▶ button to enter and select different 3D Format.
3D Sync Out Delay	Press the cursor ◀▶ button to adjust 3D sync out signal delay.
3D Sync Input	Press the cursor ◀▶ button to enter and enable or disable 3D Sync input.

**Note:**

1. The 3D OSD menu item is gray if there is no appropriate 3D source. This is the default setting.
2. When the projector is connected to an appropriate 3D source, the 3D OSD menu item is enabled for selection.
3. Use 3D glasses to view a 3D image.
4. You need 3D content from a 3D DVD or 3D media file.
5. You need to enable the 3D source (some 3D DVD content may have a 3D on-off selection feature).
6. You need DLP link 3D or IR 3D shutter glasses. With IR 3D shutter glasses, you need to install a driver on your PC and connect a USB emitter.
7. The 3D mode of the OSD needs to match the type of glasses (DLP link or IR 3D).
8. Power on the glasses. Glasses normally have a power on -off switch. Each type of glasses has their own configuration instructions. Please follow the configuration instructions that come with your glasses to finish the setup process.
9. Passive 3D is not going to support thru 3D Sync In/Out.

**Note:**

Since different types of glass (DLP link or IR shutter glass) have their own setting instructions, Please follow the guide to finish the setup process.

## Advanced 2 Feature

Press the **Menu** button to open the **OSD** menu. Press ◀▶ to move to the **Settings 1** menu. Press ▲▼ to move to the **Advanced 2** menu and then press **Enter** or ▶. Press ▲▼ to move up and down in the **Advanced 2** menu. Press ◀▶ to enter and change values for setting.

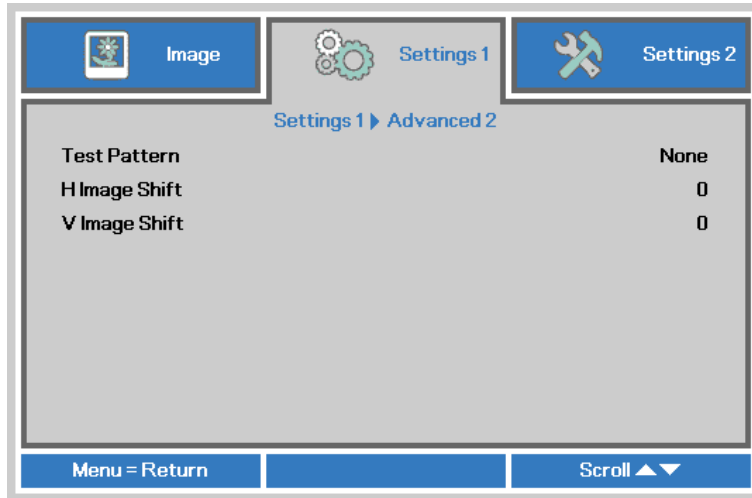

ITEM	DESCRIPTION
Test Pattern	Press the cursor ◀▶ button to enter and select internal test pattern.
H Image Shift	Press the cursor ◀▶ button to enter and set H Image Shift.
V Image Shift	Press the cursor ◀▶ button to enter and set V Image Shift.

## 4 Corner

Press ◀ (Enter) / ▶ to enter the **4 Corner** sub menu.

1. Press the cursor ▲ / ▼ buttons to select a corner and press **ENTER**.

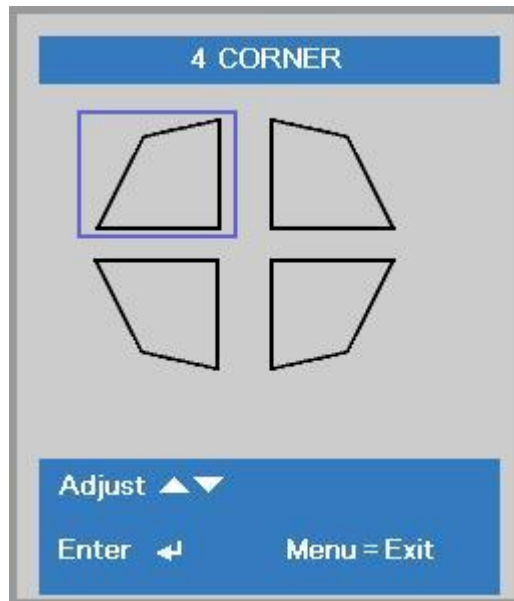

2. Press the cursor ▲ / ▼ buttons to adjust vertical and press the cursor ◀ / ▶ buttons to adjust horizontal.
3. Press **MENU** to save and Exit the settings.

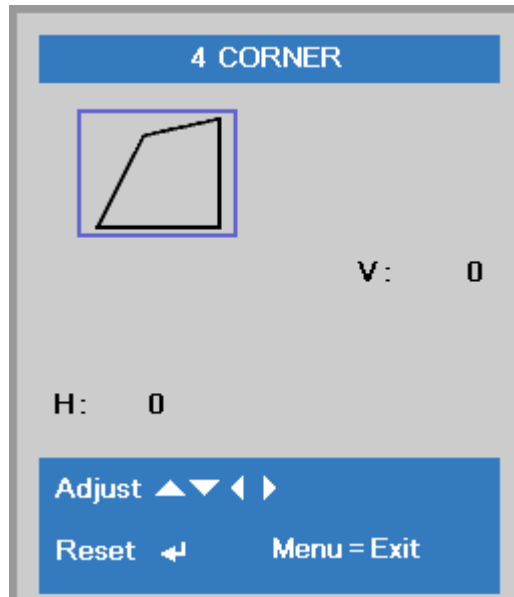

## Settings 2 Menu

Press the **MENU** button to open the **OSD** menu. Press the cursor ◀▶ button to move to the **Settings 2** menu. Press the cursor ▲▼ button to move up and down in the **Settings 2** menu.

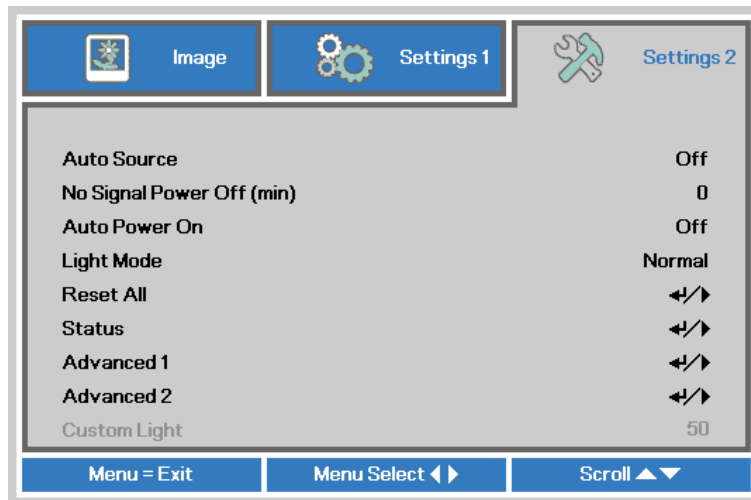

ITEM	DESCRIPTION
Auto Source	Press the cursor ◀▶ button to enter and enable or disable automatic source detection.
No Signal Power Off (min.)	Press the cursor ◀▶ button to enter and set automatic shutdown of Light source when no signal.
Auto Power On	Press the cursor ◀▶ button to enter and enable or disable automatic power On when AC power is supplied.
Light Mode	Press the cursor ◀▶ button to enter and select the Light mode for higher brightness or lower brightness to save light source life.
Reset All	Press ◀ (Enter) / ▶ to reset all settings to default values.
Status	Press ◀ (Enter) / ▶ to enter the Status menu. See page 41 for more information on <a href="#">Status</a> .
Advanced 1	Press ◀ (Enter) / ▶ to enter the Advanced 1 menu. See <a href="#">Advanced 1 Feature</a> on page 42.
Advanced 2	Press ◀ (Enter) / ▶ to enter the Advanced 2 menu. See <a href="#">Advanced 2 Feature</a> on page 54.
Custom Light	In Custom Light mode press the cursor ◀▶ button to enter and adjust the brightness of the projectors to similarity. Note: When Light Mode set to Custom Light, Custom Light function Enable.

**Note :**

**Extreme Dimming:** Saving 50% light source power consumption by blank screen (press BLANK button)

## Status

Press the cursor ▲▼ button to move up and down in the **Settings 2** menu. Select the **Status** menu and press **Enter** or ► to enter.

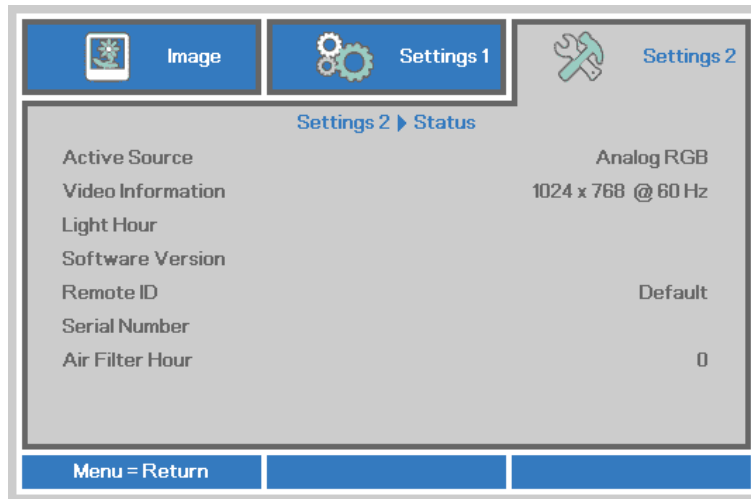

ITEM	DESCRIPTION
Active Source	Display the activated source.
Video Information	Displays resolution/video information for RGB source and color standard for Video source.
Light Hour	Light hour used information is displayed.
Software Version	Showing system software version.
Remote ID	Showing Remote Controller ID
Serial Number	Showing serial number of product.
Air Filter Hour	Displays the number of hours the air filter has been in use.

## Advanced 1 Feature

Press the **Menu** button to open the **OSD** menu. Press ◀▶ to move to the **Settings 2** menu. Press ▲▼ to move to the **Advanced 1** menu and then press **Enter** or ▶. Press ▲▼ to move up and down in the **Advanced 1** menu. Press ◀▶ to enter and change values for setting.

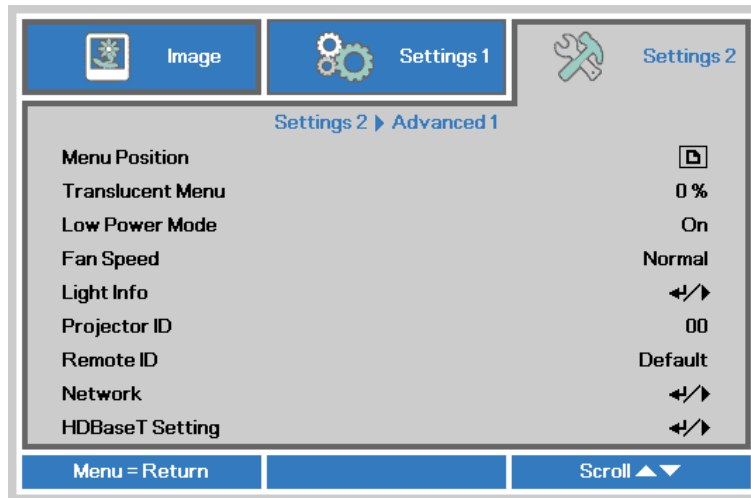

ITEM	DESCRIPTION
Menu Position	Press the cursor ◀▶ button to enter and select different OSD location.
Translucent Menu	Press the cursor ◀▶ button to enter and select OSD background translucent level.
Low Power Mode	Press the cursor ◀▶ button to enter and turn Low Power Mode On or On By Lan.
Fan Speed	Press the cursor ◀▶ button to enter and toggle between Normal and High fan speeds. <b>Note:</b> We recommend selecting high speed in high temperatures, high humidity, or high altitude (higher than 1500m/4921ft) areas.
Light Info	Press ◀ (Enter) / ▶ to enter the Light Info menu to display the light hours for each light mode.
Projector ID	Press the cursor ◀▶ button to enter and adjust a two digit projector ID from 00 through 98.
Remote ID	Press the cursor ◀▶ buttons to select remote ID to fit the current remote ID settings.
Network	Press ◀ (Enter) / ▶ to enter the Network menu. See page 43 for more information on <a href="#">Network</a> .
HDBaseT Setting	Press ◀ (Enter) / ▶ to enter the HDBaseT Setting menu. See page 54 for more information on <a href="#">HDBaseT Setting</a> .

**Note:**

About “**On By Lan**”, RJ45 will support to be waked up in this mode(Under 3W) but scalar won't.

**Note:**

1. Remoter with Default customer code will be available for any Remote ID setting on the OSD.
2. Status key will be available for any Remote ID setting on the OSD
3. IF users forget the current Remote ID setting, please press the Status key to call out the INFORMATION OSD to check the current Remote ID setting and then adjust the ID on the remoter to meet the OSD setting.
4. After adjusting Remote ID from OSD, only if the OSD Menu has been closed then the new ID value can be taken effected and memorized.
5. The setting value “Default” means ID 0 on the remoter.

## Network

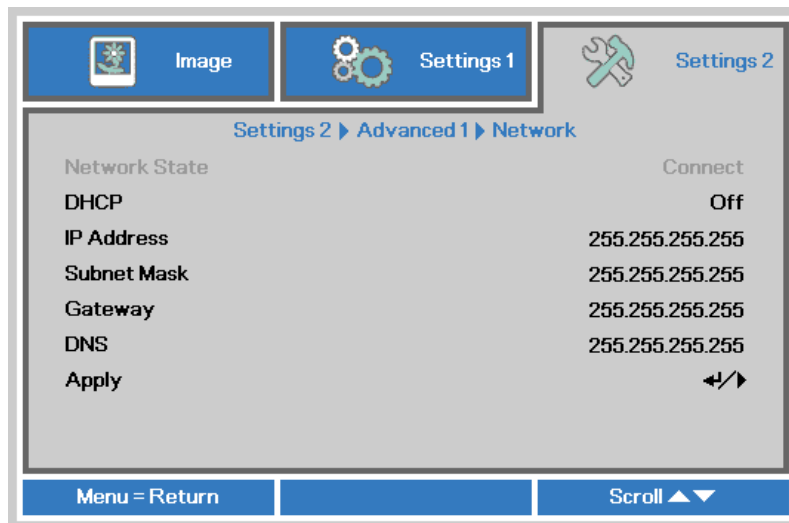

ITEM	DESCRIPTION
Network State	Displays the network connection status.
DHCP	Press ◀▶ to turn DHCP On or Off. <b>Note:</b> If you select DHCP Off, complete the IP Address, Subnet Mask, Gateway, and DNS fields.
IP Address	Enter a valid IP address if DHCP is turned off.
Subnet Mask	Enter a valid Subnet Mask if DHCP is turned off.
Gateway	Enter a valid Gateway address if DHCP is turned off.
DNS	Enter a valid DNS name if DHCP is turned off.
Apply	Press ◀ (Enter) / ▶ to confirm settings.

## LAN\_RJ45

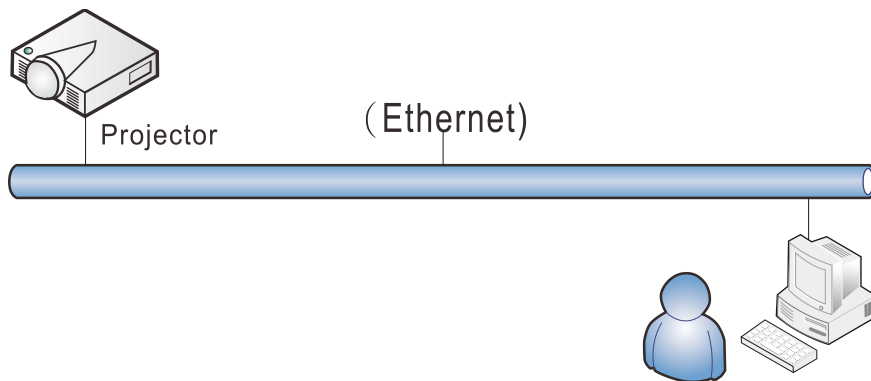

### Wired LAN Terminal functionalites

Remote control and monitoring of a projector from a PC (or Laptop) via wired LAN is also possible. Compatibility with Crestron / AMX (Device Discovery) / Extron control boxes enables not only collective projector management on a network but also management from a control panel on a PC (or Laptop) browser screen.

- ★ Crestron is a registered trademark of Crestron Electronics, Inc. of the United States.
- ★ Extron is a registered trademark of Extron Electronics, Inc. of the United States.
- ★ AMX is a registered trademark of AMX LLC of the United States.
- ★ PJLink applied for trademark and logo registration in Japan, the United States of America, and other countries by JBMIA.

### Supported External Devices

This projector is supported by the specified commands of the Crestron Electronics controller and related software (ex, RoomView ®).

<http://www.crestron.com/>

This projector is supported by AMX ( Device Discovery ).

<http://www.amx.com/>

This projector is compliant to support Extron device(s) for reference.

<http://www.extron.com/>

This projector supports all commands of PJLink Class1 (Version 1.00).

<http://pjlink.jbmia.or.jp/english/>

For more detail of information about the diverse types of external devices which can be connected to the LAN/RJ45 port and remote/control the projector, as well as the related control commands supporting for each external device, kindly please get contact with the Support-Service team directly.



## LAN RJ45

1. Connect an RJ45 cable to RJ45 ports on the projector and the PC (Laptop).

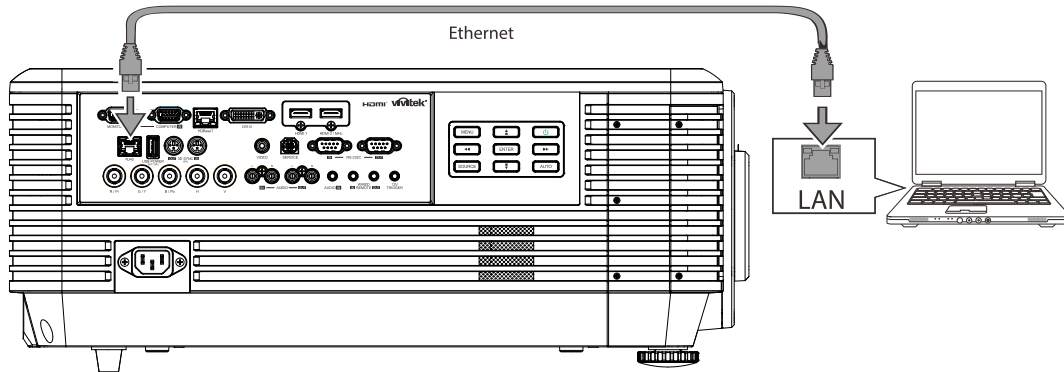

2. On the PC (Laptop), select **Start** → **Control Panel** → **Network and Internet**.

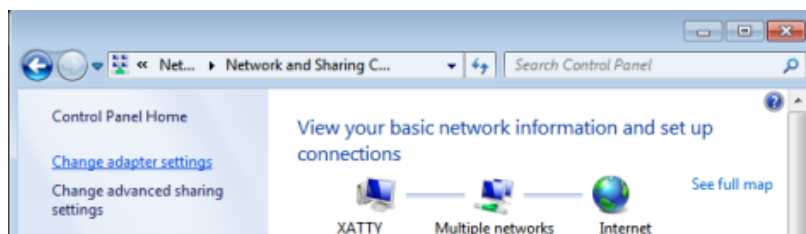
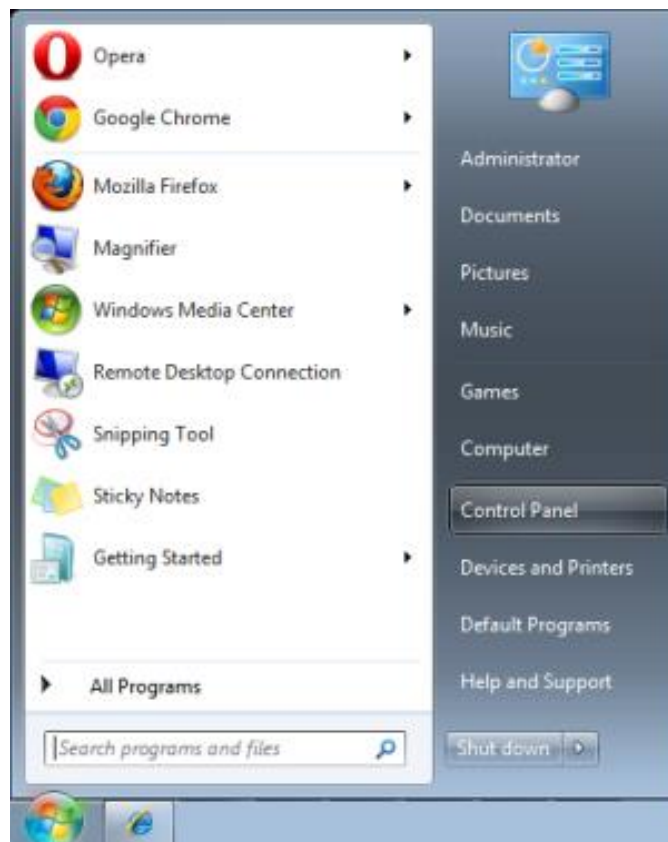

3. Right-click on **Local Area Connection**, and select **Properties**.

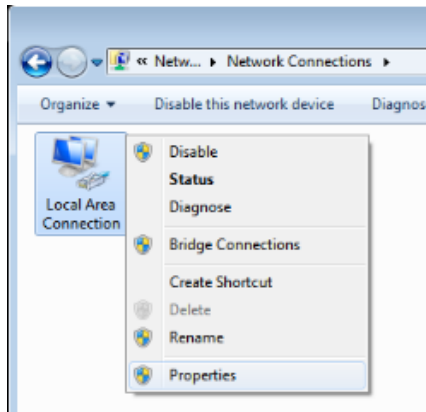

4. In the **Properties** window, select the **Networking** tab, and select **Internet Protocol (TCP/IP)**.
5. Click **Properties**.

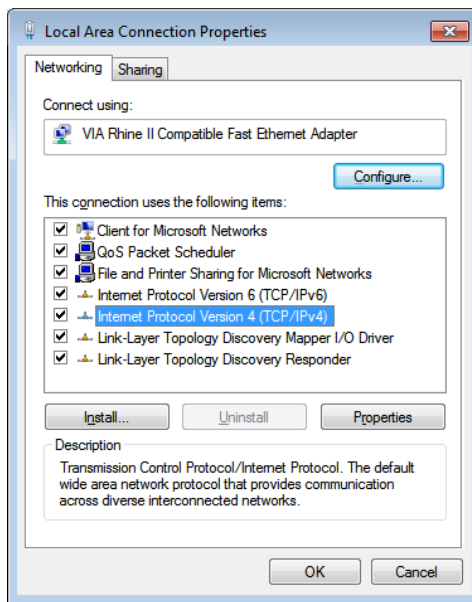

6. Click **Use the following IP address** and fill in the IP address and Subnet mask, then click **OK**.

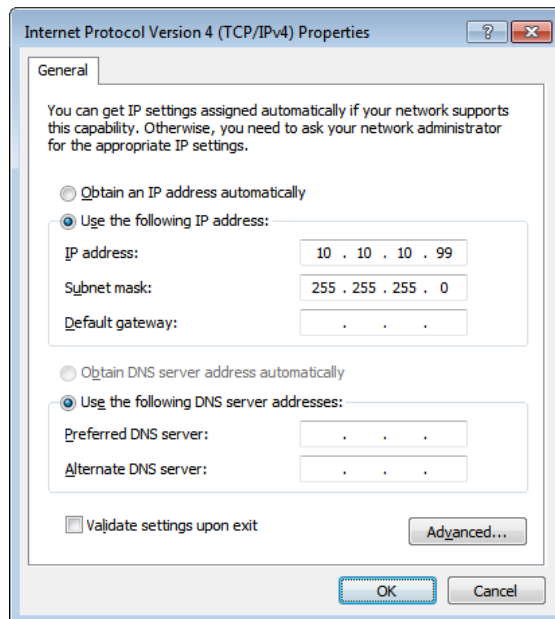

7. Press the **Menu** button on the projector.
8. Select **Settings2** → **Advanced1** → **Network**
9. After getting into **Network**, input the following:
  - ▶ DHCP: Off
  - ▶ IP Address: 10.10.10.10
  - ▶ Subnet Mask: 255.255.255.0
  - ▶ Gateway: 0.0.0.0
  - ▶ DNS Server: 0.0.0.0
10. Press **↵** (Enter) / **▶** to confirm settings.  
 Open a web browser  
 (for example, Microsoft Internet Explorer with Adobe Flash Player 9.0 or higher).

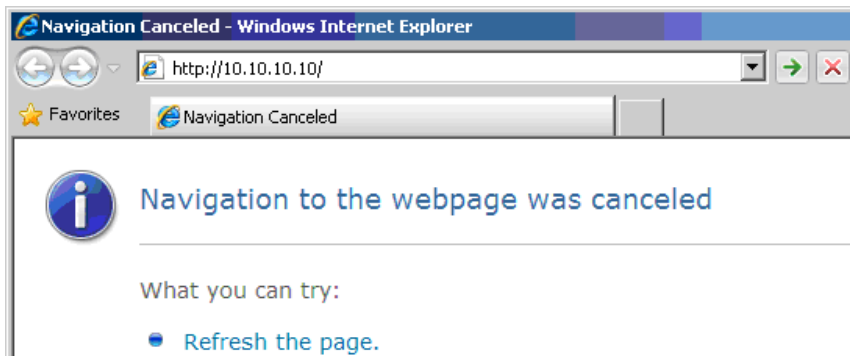

11. In the Address bar, input the IP address: 10.10.10.10.
12. Press **↵** (Enter) / **▶**.  
 The projector is setup for remote management. The LAN/RJ45 function displays as follows.

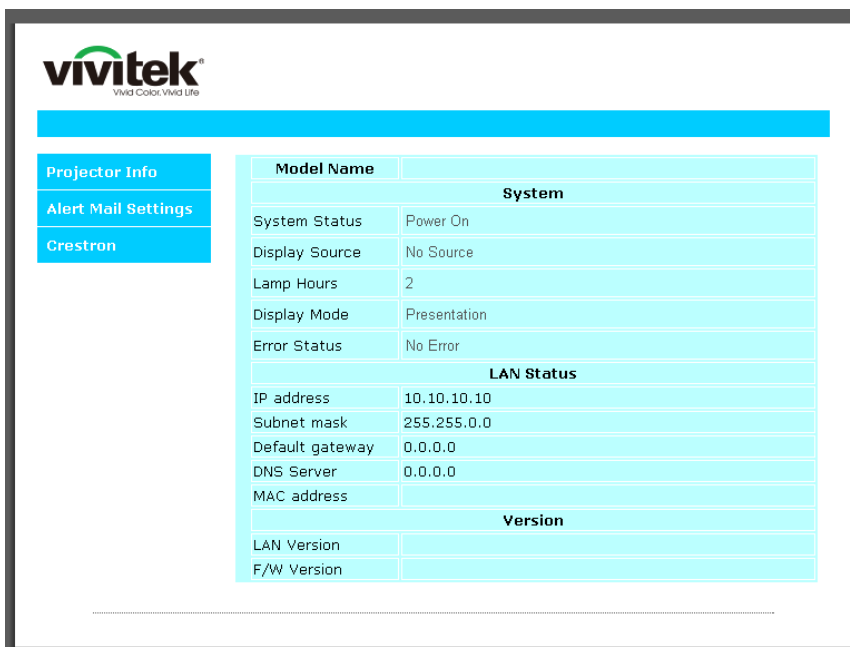



**CRESTRON** Expansion Options

Crestron Control	Projector	User Password
IP Address <input type="text"/>	Projector Name <input type="text" value="PJ01"/>	<input type="checkbox"/> Usr Enabled
IP ID <input type="text"/>	Location <input type="text" value="RM01"/>	Password <input type="text"/>
Control Port <input type="text"/>	Assigned To <input type="text" value="Sir"/>	Confirmed <input type="text"/>
<input type="button" value="Control Set"/>	<input type="button" value="Set"/>	<input type="button" value="Usr Set"/>
	Network Config <input type="checkbox"/> DHCP Enabled	Admin Password
	IP Address <input type="text" value="10.10.10.10"/>	<input type="checkbox"/> Adm Enabled
	Subnet Mask <input type="text" value="255.255.255.0"/>	Password <input type="text"/>
	Default Gateway <input type="text" value="0.0.0.0"/>	Confirmed <input type="text"/>
	DNS Server <input type="text" value="0.0.0.0"/>	<input type="button" value="Adm Set"/>
	<input type="button" value="Net Set"/>	
	<input type="button" value="Tools Exit"/>	

CATEGORY	ITEM	INPUT-LENGTH
Crestron Control	IP Address	15
	IP ID	3
	Port	5
Projector	Projector Name	10
	Location	10
	Assigned To	10
Network Configuration	DHCP (Enabled)	(N/A)
	IP Address	15
	Subnet Mask	15
	Default Gateway	15
	DNS Server	15
User Password	Enabled	(N/A)
	New Password	10
	Confirm	10
Admin Password	Enabled	(N/A)
	New Password	10
	Confirm	10

For more information, please visit <http://www.crestron.com>.

### Preparing Email Alerts

1. Make sure that user can access the homepage of LAN RJ45 function by web browser (for ex-ample, Microsoft Internet Explorer v6.01/v8.0).
2. From the Homepage of LAN/RJ45, click **Alert Settings**.

The screenshot shows the Vivitek web interface. On the left, there is a navigation menu with three items: 'Projector Info', 'Alert Mail Settings' (which is circled in red), and 'Crestron'. The main content area displays a table of system and LAN status information.

Model Name	
<b>System</b>	
System Status	Power On
Display Source	No Source
Lamp Hours	2
Display Mode	Presentation
Error Status	No Error
<b>LAN Status</b>	
IP address	10.10.10.10
Subnet mask	255.255.0.0
Default gateway	0.0.0.0
DNS Server	0.0.0.0
MAC address	
<b>Version</b>	
LAN Version	
F/W Version	

3. By default, these input boxes in **Alert Settings** are blank.

The screenshot shows the 'Send E-Mail' configuration page. It includes a sidebar with 'Projector Info', 'Alert Mail Settings', and 'Crestron'. The main area is titled 'Send E-Mail' and contains a form for configuring email alerts. The form includes fields for SMTP Server, User Name, Password, From, To, and CC, along with checkboxes for various alert options. A 'Send Test Mail' button is at the bottom.

**Send E-Mail**  
Enter the appropriate settings in the fields below:  
(Your SMTP server may not require a user name or password.)

SMTP Server:  Port:

User Name:

Password:

From:

To:

CC:

**E-mail Alert Options:**

Fan lock :  Over\_Heat:

Case Open:  Lamp Fail:

Lamp Hours Over:  Filter Hours Over:

Weekly Report:

4. For Sending alert mail, input the following:

The **SMTP** field is the mail server for sending out email (SMTP protocol). This is a required field.

The **To** field is the recipient's email address (for example, the projector administrator). This is a required field.

The **Cc** field sends a carbon copy of the alert to the specified email address. This is an optional field (for example, the projector administrator's assistant).

The **From** field is the sender's email address (for example, the projector administrator). This is a required field.

Select the alert conditions by checking the desired boxes.

**vivitek**  
Vivid Color. Vivid Life.

**Projector Info**  
**Alert Mail Settings**  
Crestron

### Send E-Mail

Enter the appropriate settings in the fields below:  
(Your SMTP server may not require a user name or password.)

**SMTP Server:** mail.corp.com **Port:** 25  
**User Name:** Sender.US  
**Password:** \*\*\*\*\*  
Mail Server Apply

**From:** send@mail.corp.com  
**To:** rcvr1@mail.corp.com  
**CC:** rcvr2@mail.corp.com  
Mail Address Apply

**E-mail Alert Options:**  
Fan lock :  **Over\_Heat:**   
Case Open:  **Lamp Fail:**   
Lamp Hours Over:  **Filter Hours Over:**   
Weekly Report:   
Alert Option Apply

Send Test Mail

**Note:** Fill in all fields as specified. User can click **Send Test Mail** to test what setting is correct. For successful sending an e-mail alert, you must select alert conditions and enter a correct e-mail address.

### RS232 by Telnet Function

Besides projector connected to RS232 interface with “Hyper-Terminal” communication by dedicated RS232 command control, there is alternative RS232 command control way, so called “RS232 by TELNET” for LAN/RJ45 interface.

#### Quick Start-Guide for “RS232 by TELNET”

Check and get the IP-Address on OSD of the projector.

Make sure that laptop/PC can access the web-page of the projector.

Make sure that “Windows Firewall” setting to be disabled in case of “TELNET” function filtering out by laptop/PC.

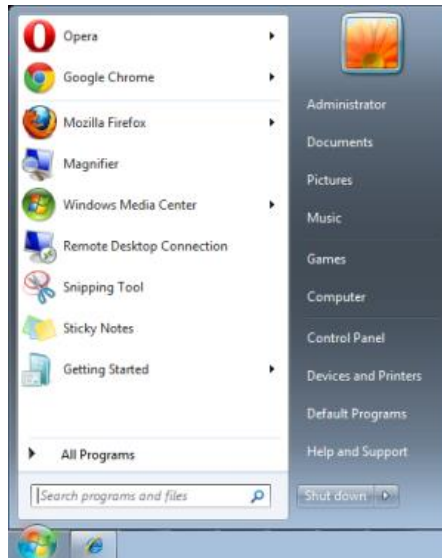

Start => All Programs => Accessories => Command Prompt

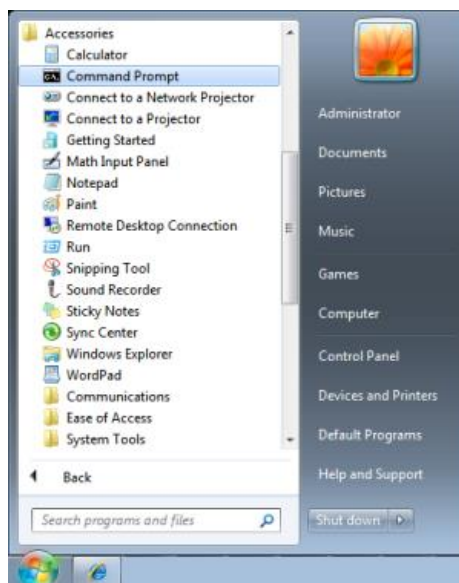

Input the command format like the below:

**telnet ttt.xxx.yyy.zzz 23** (“Enter” key pressed)

(**ttt.xxx.yyy.zzz**: IP-Address of the projector)

If Telnet-Connection ready, and user can have RS232 command input, then “Enter” key pressed, the RS232 command will be workable.

### How to have TELNET enabled in Windows VISTA / 7 / 8

By default installation for Windows VISTA / 7 / 8, “TELNET” function is not included. But end-user can have it by way of “Turn Windows features On or Off” to be enabled.

Open “Control Panel” in Windows VISTA / 7 / 8

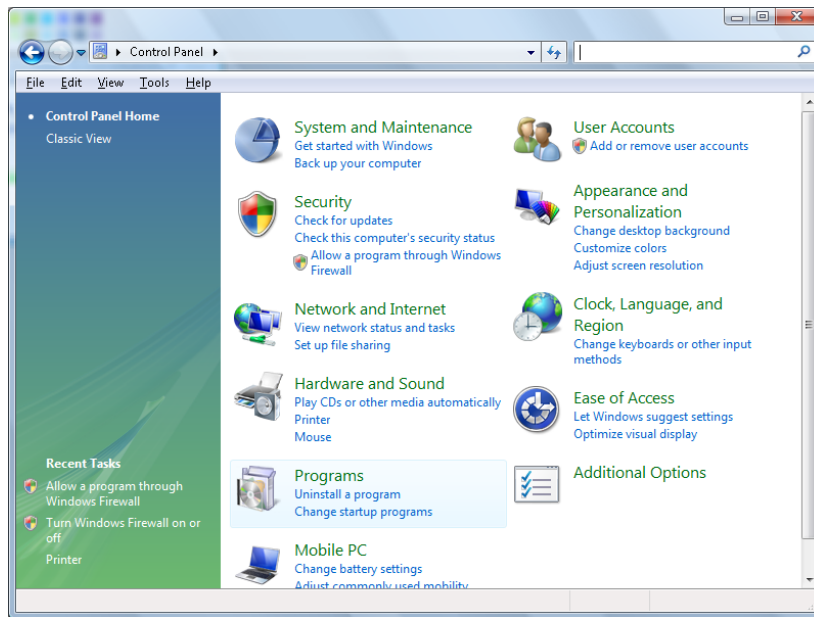

Open “Programs”

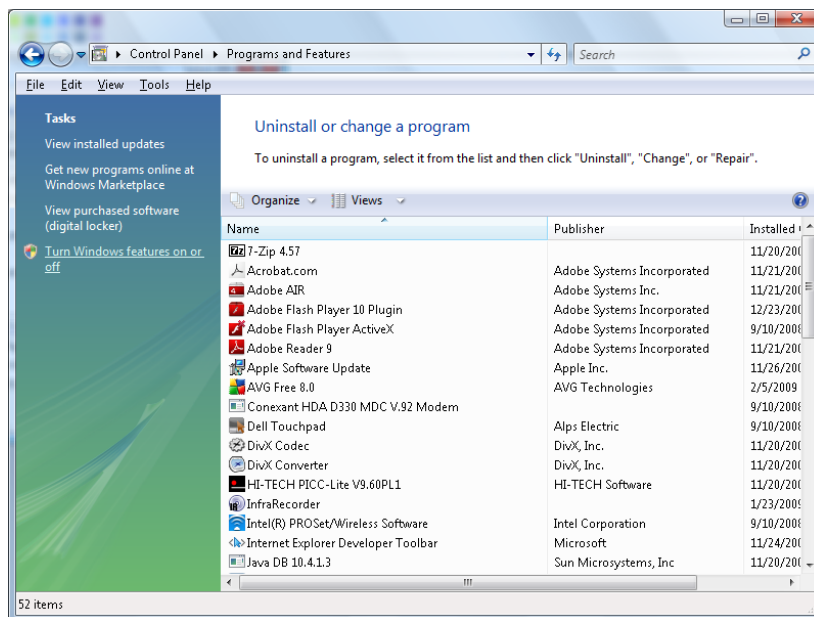



Select “Turn Windows features on or off” to open

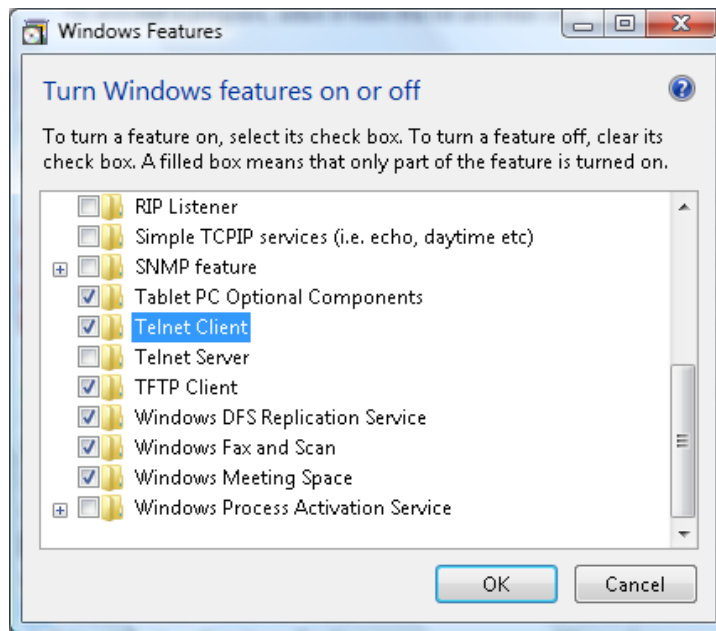

Have “Telnet Client” option checked, then press “OK” button.

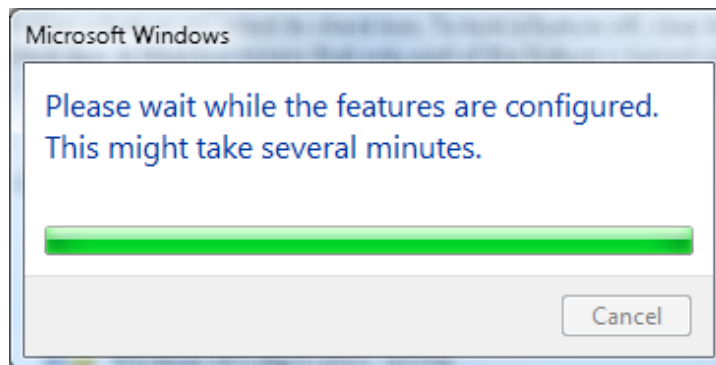

### Specsheet for “RS232 by TELNET” :

1. Telnet: TCP
2. Telnet port: 23  
(for more detail, kindly please get contact with the service agent or team)
3. Telnet utility: Windows “TELNET.exe” (console mode)
4. Disconnection for RS232-by-Telnet control normally: Close Windows Telnet utility directly after TELNET connection ready
5. Limitation 1 for Telnet-Control: there is less than 50 bytes for successive network payload for Telnet-Control application.  
Limitation 2 for Telnet-Control: there is less than 26 bytes for one complete RS232 command for Telnet-Control.  
Limitation 3 for Telnet-Control: Minimum delay for next RS232 command must be more than 200 (ms).  
(\* , In Windows built-in “TELNET.exe” utility, “Enter” key pressed will have “Carriage-Return” and “New-Line” code.)

## HDBaseT Setting

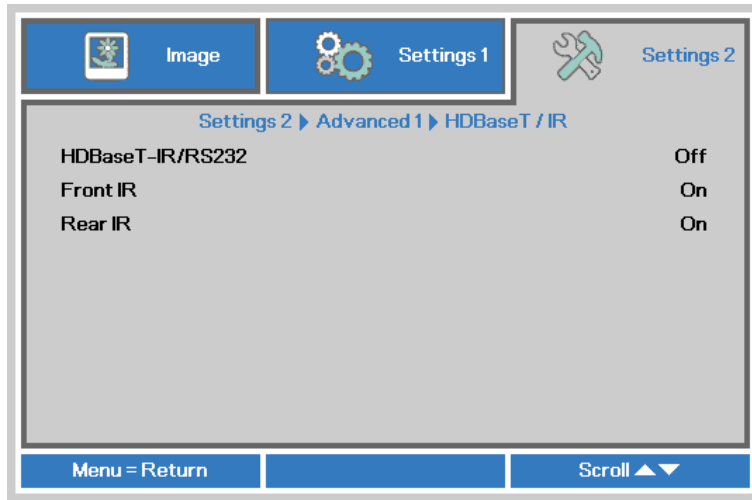

ITEM	DESCRIPTION
HDBaseT-IR/RS232	Press the cursor ◀▶ button to enter and enable or disable HDBaseT Control.
Front IR	Press the cursor ◀▶ button to enter and enable or disable Front IR.
Rear IR	Press the cursor ◀▶ button to enter and enable or disable Rear IR.

**Note:**

1. Enable **HDBaseT control** function when you desire to use HDBaseT TX box. (Remove RS232 and RJ45/LAN control function from Projector to HDBaseT TX box.) See HDBaseT control function table.
2. When HDBaseT enable, **Low Power Mode** will auto set to **On by HDBaseT**.
3. **HDBaseT control** is disabled when the HDBaseT TX box signal is cutoff.

### HDBaseT control function table

Control Side	Function	Projector Mode			Remark
		Low Power Mode On(<0.5W)	Low Power Mode On by lan(<3W)	HDBaseT control Enable Low Power Mode On by HDBaseT(<6W)	
Projector	Front-IR(wireless)	O	O	O(Can disable by OSD)	
	Rear-IR(wireless)	O	O	O(Can disable by OSD)	
	RS-232	O	O	X	
	RJ45/LAN	X	O	X	
	Wired remote	O	O	O	
HDBaseT TX Box	HDBT-IR(wireless)	X	X	O	
	RS-232	X	X	O	
	RJ45/LAN	X	X	O	
	Wired remote	X	X	O	User can connect wired remote at HDBaseT TX side to get the wired function.

O : Enable      X : Disable

## Advanced 2 Feature

Press the **Menu** button to open the **OSD** menu. Press ◀▶ to move to the **Settings 2** menu. Press ▲▼ to move to the **Advanced 2** menu and then press **Enter** or ▶. Press ▲▼ to move up and down in the **Advanced 2** menu. Press ◀▶ to enter and change values for setting.

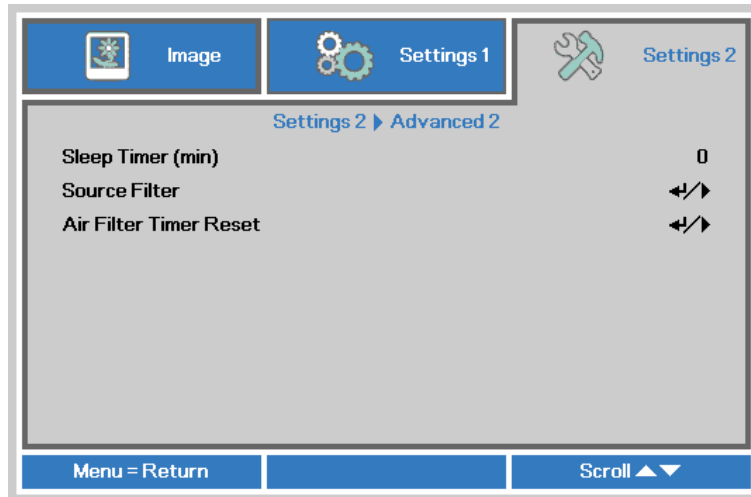

ITEM	DESCRIPTION
Sleep Timer	Press the cursor ◀▶ button to enter and set Sleep timer. The projector automatically turns off after the preset period of time.
Source Filter	Press ◀ (Enter) / ▶ to enter the Source Filter menu. See page 56 for more information on <a href="#">Source Filter</a> .
Air Filter Timer Reset	Press ◀ (Enter) / ▶ to reset air filter timer.

## Source Filter

Press the **ENTER** button to enter the **Source Filter** sub menu.



ITEM	DESCRIPTION
HDMI1	Press the cursor ◀▶ button to enter and enable or disable the HDMI1 source.
HDMI2/MHL	Press the cursor ◀▶ button to enter and enable or disable the HDMI2 / MHL-compatible source.
DVI	Press the cursor ◀▶ button to enter and enable or disable the DVI source.
VGA1	Press the cursor ◀▶ button to enter and enable or disable the VGA1 source.
BNC	Press the cursor ◀▶ button to enter and enable or disable the BNC source.
Composite Video	Press the cursor ◀▶ button to enter and enable or disable the Composite Video source.
HDBaseT	Press the cursor ◀▶ button to enter and enable or disable the HDBaseT source.

## MAINTENANCE AND SECURITY

### Cleaning the Projector

Cleaning the projector to remove dust and grime will help ensure trouble-free operation.

**Warning:**

1. Be sure to turn off and unplug the projector at least 30 minutes before cleaning. Failure to do so could result in a severe burn.
2. Use only a dampened cloth when cleaning. Do not allow water to enter the ventilation openings on the projector.
3. If a little water gets into the projector interior while cleaning, leave unplugged in a well-ventilated room for several hours before using.
4. If a lot of water gets into the projector interior when cleaning, have the projector serviced.

### Cleaning the Lens

You can purchase optic lens cleaner from most camera stores. Refer to the following to clean the projector lens.

1. Apply a little optic lens cleaner to a clean soft cloth. (Do not apply the cleaner directly to the lens.)
2. Lightly wipe the lens in a circular motion.

**Caution:**

1. Do not use abrasive cleaners or solvents.
2. To prevent discoloration or fading, avoid getting cleaner on the projector case.

### Cleaning the Case

Refer to the following to clean the projector case.

1. Wipe off dust with a clean dampened cloth.
2. Moisten the cloth with warm water and mild detergent (such as used to wash dishes), and then wipe the case.
3. Rinse all detergent from the cloth and wipe the projector again.

**Caution:**

To prevent discoloration or fading of the case, do not use abrasive alcohol-based cleaners.

## Cleaning the Air Filter

The air filter prevents dust from accumulating on the surface of the optical elements inside the projector. If the filter is dirty or clogged, your projector may overheat or degrading the projected image quality.

- 1.** Turn off the projector, and unplug the AC power cord from the AC outlet.
- 2.** Cleaning the filter with a vacuum cleaner.

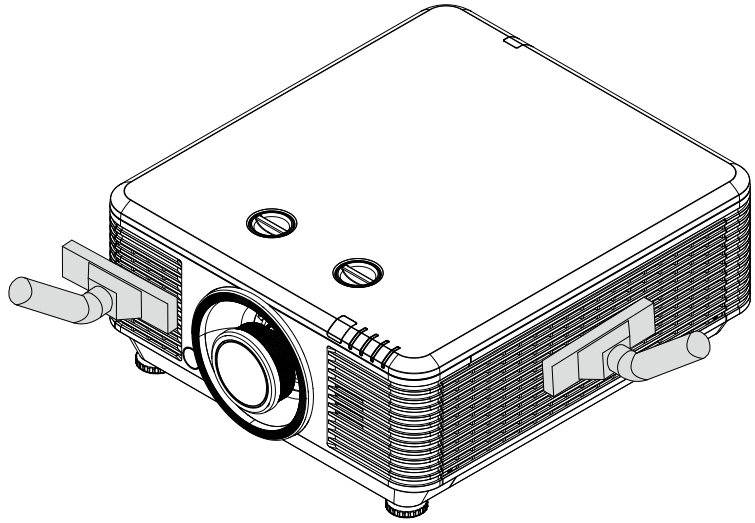

**Caution:**

*Recommend avoiding dusty or smoky environments when you operate the projector, it may cause poor image quality.*

*If the filter is heavily clogged and unable to clean, replace a new filter.*

**Note:**

*Using a ladder is recommended to access the filter. Do not remove the projector from the wall mount.*

## Replacing the Filter

1. Turn off the projector, and unplug the AC power cord from the AC outlet.

Clean up the dust on the projector and around the air vents.

Remove the screws from the filter module.

Loosen Screws on the filter module.

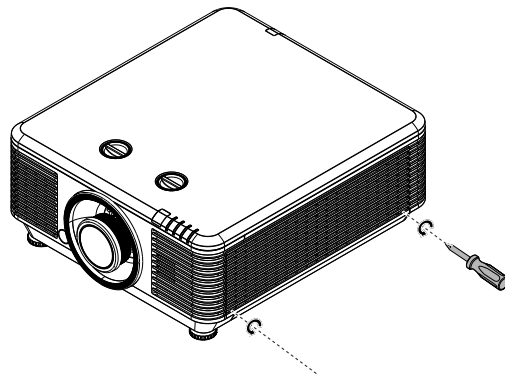
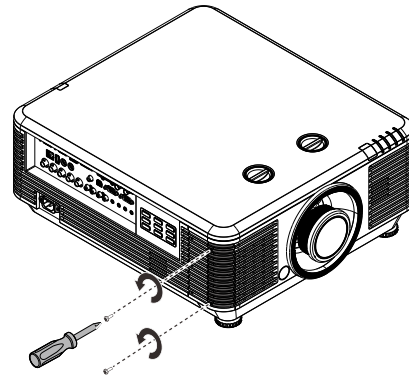

2. Remove the filter module from the projector

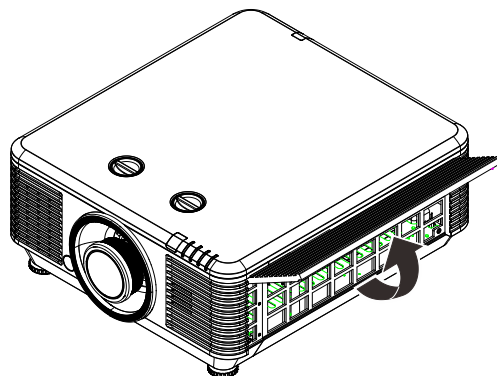
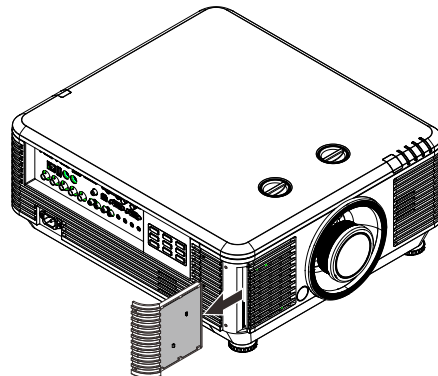

- 3.** Lift the filter from the filter cover.

Replace a new filter into cover.

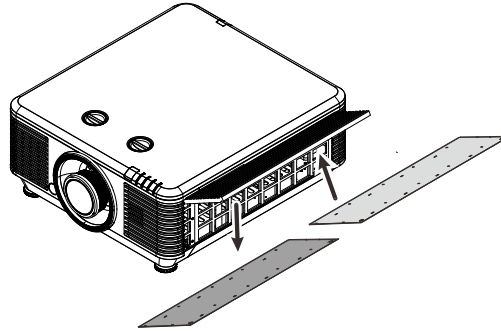
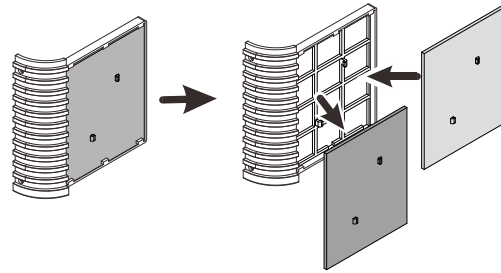

- 4.** Replace the filter cover back to the projector.

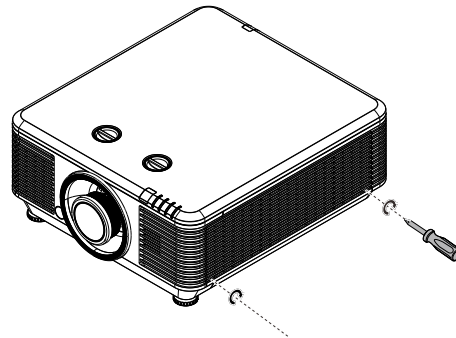
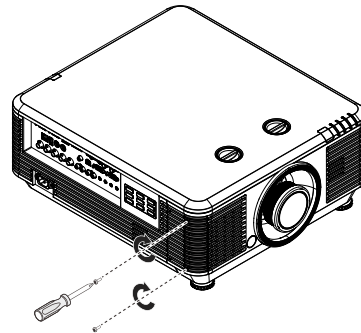

- 5.** Turn on the projector and reset the Air Filter Timer after the Air Filter is replaced.  
Air Filter Timer Reset:  
Press **MENU** > Select **Settings 2** >> **Advanced 2** and select **Air Filter Timer Reset**.  
Press **←** (Enter) / **▶** to reset timer.



**Warning:**

*Do not wash the filter with the water or other liquid matter.*



**Important:**

*The Filter LED lights when the filter service time is on.  
If the filter is broken, please use a new one.*



## Using the Physical Lock

### Using the Kensington Security Slot

If you are concerned about security, attach the projector to a permanent object with the Kensington slot and a security cable.



**Note:**

Contact your vendor for details on purchasing a suitable Kensington security cable.

The security lock corresponds to Kensington's MicroSaver Security System. If you have any comment, contact: Kensington, 2853 Campus Drive, San Mateo, CA 94403, U.S.A. Tel: 800-535-4242, <http://www.Kensington.com>.

### Using the Security Bar Lock

In addition to the password protection function and the Kensington lock, the Security Bar Opening helps protect the projector from unauthorized use.

See the following picture.

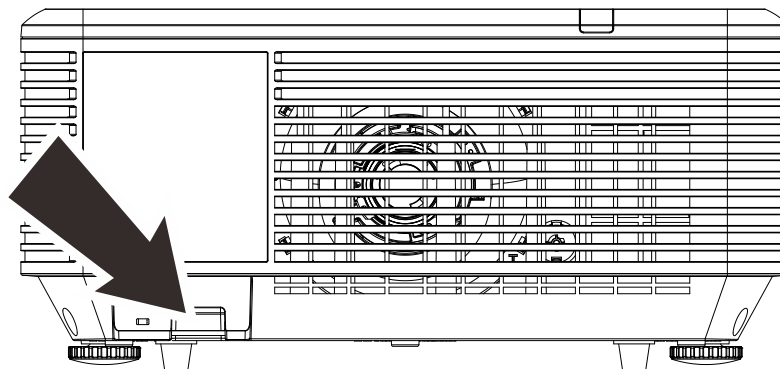

## **Common Problems and Solutions**

These guidelines provide tips to deal with problems you may encounter while using the projector. If the problem remains unsolved, contact your dealer for assistance.

Often after time spent troubleshooting, the problem is traced to something as simple as a loose connection. Check the following before proceeding to the problem-specific solutions.

- *Use some other electrical device to confirm that the electrical outlet is working.*
- *Ensure the projector is turned on.*
- *Ensure all connections are securely attached.*
- *Ensure the attached device is turned on.*
- *Ensure a connected PC is not in suspending mode.*
- *Ensure a connected notebook computer is configured for an external display. (This is usually done by pressing an Fn-key combination on the notebook.)*

## **Tips for Troubleshooting**

In each problem-specific section, try the steps in the order suggested. This may help you to solve the problem more quickly.

Try to pin point the problem and thus avoid replacing non-defective parts.

For example, if you replace batteries and the problem remains, put the original batteries back and go to the next step.

Keep a record of the steps you take when troubleshooting: The information may be useful when calling for technical support or for passing on to service personnel.

## LED Error Messages

ERROR CODE MESSAGES	POWER LED	LIGHT LED	TEMP LED	FILTER LED
Light Source Ready	ON	OFF	OFF	OFF
Start	Flashing	OFF	OFF	OFF
Cooling	Flashing	OFF	OFF	OFF
Over Temperature T1	OFF	1 blinks	ON	OFF
Over Temperature T2	OFF	2 blinks	ON	OFF
Over Temperature T3	OFF	3 blinks	ON	OFF
Over Temperature T4	OFF	4 blinks	ON	OFF
Over Temperature T5	OFF	5 blinks	ON	OFF
Thermal Break Sensor error	4 blinks	OFF	OFF	OFF
FAN1 error	6 blinks	1 blinks	OFF	OFF
FAN2 error	6 blinks	2 blinks	OFF	OFF
FAN3 error	6 blinks	3 blinks	OFF	OFF
FAN4 error	6 blinks	4 blinks	OFF	OFF
FAN5 error	6 blinks	5 blinks	OFF	OFF
FAN6 error	6 blinks	6 blinks	OFF	OFF
FAN7 error	6 blinks	7 blinks	OFF	OFF
FAN8 error	6 blinks	8 blinks	OFF	OFF
FAN9 error	6 blinks	9 blinks	OFF	OFF
1W MCU detects scaler stops working	2 blinks	OFF	OFF	OFF
Case Open	7 blinks	OFF	OFF	OFF
Lens Open	7 blinks	1 blinks	OFF	OFF
DMD error	8 blinks	OFF	OFF	OFF
Color wheel error	9 blinks	1 blinks	OFF	OFF
Phosphor wheel error	9 blinks	OFF	OFF	OFF
Air Filter replace warning	ON	OFF	OFF	ON

In the event of an error, please disconnect the AC power cord and wait for one (1) minute before restarting the projector. If the Power or Light source LEDs are still blinking or the Over Temp LED is lit, contact your service center.

## Image Problems

### ***Problem: No image appears on the screen***

1. Verify the settings on your notebook or desktop PC.
2. Turn off all equipment and power up again in the correct order.

### ***Problem: The image is blurred***

1. Adjust the **Focus** on the projector.
2. Press the **Auto** button on the remote control or projector.
3. Ensure the projector-to-screen distance is within the specified range.
4. Check that the projector lens is clean.

### ***Problem: The image is wider at the top or bottom (trapezoid effect)***

1. Position the projector so it is as perpendicular to the screen as possible.
2. Use the **Keystone** button on the remote control or projector to correct the problem.

***Problem: The image is reversed***

Check the **Projection** setting on the **Settings 1** menu of the OSD.

***Problem: The image is streaked***

1. Set the **Frequency** and **Tracking** settings on the **Image->Computer** menu of the OSD to the default settings.
2. To ensure the problem is not caused by a connected PC's video card, connect to another computer.

***Problem: The image is flat with no contrast***

Adjust the **Contrast** setting on the **Image** menu of the OSD.

***Problem: The color of the projected image does not match the source image.***

Adjust the **Color Temperature** and **Gamma** settings on the **Image->Advanced** menu of the OSD.

## Light Source Problems

***Problem: There is no light from the projector***

1. Check that the power cable is securely connected.
2. Ensure the power source is good by testing with another electrical device.
3. Restart the projector in the correct order and check that the Power LED is on.

## Remote Control Problems

***Problem: The projector does not respond to the remote control***

1. Direct the remote control towards remote sensor on the projector.
2. Ensure the path between remote and sensor is not obstructed.
3. Turn off any fluorescent lights in the room.
4. Check the battery polarity.
5. Replace the batteries.
6. Turn off other Infrared-enabled devices in the vicinity.
7. Have the remote control serviced.

## Audio Problems

***Problem: There is no sound***

1. Adjust the volume on the remote control.
2. Adjust the volume of the audio source.
3. Check the audio cable connection.
4. Test the source audio output with other speakers.
5. Have the projector serviced.

***Problem: The sound is distorted***

1. Check the audio cable connection.
2. Test the source audio output with other speakers.
3. Have the projector serviced.

## Having the Projector Serviced

If you are unable to solve the problem, you should have the projector serviced. Pack the projector in the original carton. Include a description of the problem and a checklist of the steps you took when trying to fix the problem: The information may be useful to service personnel. For servicing, return the projector to the place you purchased it.

## **HDMI Q & A**

**Q. What is the difference between a “Standard” HDMI cable and a “High-Speed” HDMI cable?**

Recently, HDMI Licensing, LLC announced that cables would be tested as Standard or High-Speed cables.

Standard (or “category 1”) HDMI cables have been tested to perform at speeds of 75Mhz or up to 2.25Gbps, which is the equivalent of a 720p/1080i signal.

High Speed (or “category 2”) HDMI cables have been tested to perform at speeds of 340Mhz or up to 10.2Gbps, which is the highest bandwidth currently available over an HDMI cable and can successfully handle 1080p signals including those at increased color depths and/or increased refresh rates from the Source. High-Speed cables are also able to accommodate higher resolution displays, such as WQXGA cinema monitors (resolution of 2560 x 1600).

**Q. How do I run HDMI cables longer than 10 meters?**

There are many HDMI Adopters working on HDMI solutions that extend a cable’s effective distance from the typical 10 meter range to much longer lengths. These companies manufacture a variety of solutions that include active cables (active electronics built into cables that boost and extend the cable’s signal), repeaters, amplifiers as well as CAT5/6 and fiber solutions.

**Q. How can I tell if a cable is an HDMI certified cable?**

All HDMI products are required to be certified by the manufacturer as part of the HDMI Compliance Test Specification. However, there may be instances where cables bearing the HDMI logo are available but have not been properly tested. HDMI Licensing, LLC actively investigates these instances to ensure that the HDMI trademark is properly used in the market. We recommend that consumers buy their cables from a reputable source and a company that is trusted.

For more detail information check <http://www.hdmi.org/learningcenter/faq.aspx#49>

**SPECIFICATIONS**

**Specifications**

<b>Model Name</b>	DU70x Series			DU71x Series	
<b>Display Type</b>	0.67 WUXGA Type A				
<b>Resolution</b>	WUXGA 1920x1200				
<b>Lens</b>	Short Throw VL904G/LNS-5FX2	Semi Short Throw VL907G/LNS-5STZ	STD Lens VL906G/LNS-5SZ2	Long Throw VL908G/LNS-5LZ3	Super Long Throw VL909G/LNS-5LZ2
<b>Throw Ratio</b>	0.778	1.1~1.3	1.54~1.93	1.93~2.9	3~5
<b>Zoom Ratio</b>	N.A.	1.18	1.25	1.5	1.67
<b>Image size (diagonal)</b>	47.8~298.3"	35.8" ~ 379.8"	36.1~211"	32.1~481"	27.9" ~ 309.5"
<b>Projection distance</b>	0.8~5.0m	1m~9m	1.5~7m	2.0~20m	3~20m
<b>Keystone Correction</b>	<b>Vertical</b>	±30° for ±30 steps			
	<b>Horizontal</b>	±25° for ±25 steps			
<b>Projection Methods</b>	Front, Rear, Desktop/Ceiling (Rear, Front)				
<b>Data Compatibility</b>	VGA, SVGA, XGA, SXGA, SXGA+, UXGA, WUXGA@60hz, Mac				
<b>SDTV/EDTV/ HDTV</b>	480i, 480p, 576i, 576p, 720p, 1080i, 1080p				
<b>Video Compatibility</b>	NTSC/ NTSC (M, 3.58/4.43 MHz), PAL (B,D,G,H,I,M,N), SECAM (B,D,G,K,K1,L)				
<b>H-Sync</b>	15.31 – 91.4kHz				
<b>V-Sync</b>	24 - 30Hz, 47 – 120 Hz				
<b>Safety Certification</b>	FCC-B, cUL, UL, CB, CE, CCC, KC, PCT, NOM, China CECP, C-tick				
<b>Operation Temperature</b>	0° ~ 40°C				
<b>Dimensions</b>	517mm (W) x 470mm (D) x 202mm (H)				
<b>AC Input</b>	AC Universal 100 – 240, Typical @ 110VAC (100 – 240)/+/-10%				
<b>Power Consumption</b>	650W (Normal), 530W (Eco) , <0.5W (Standby), <3W (on by Lan)			830W (Normal), 640W (Eco) , <0.5W (Standby), <3W (on by Lan)	
<b>Light Source: Laser-Phosphor</b>	6 Banks			8 Banks	
<b>Audio Speaker</b>	Peak 10W x 2				
<b>Input Terminals</b>	VGA in x 1				
	DVI-D x 1				
	5 BNC (RGBHV) x 1				
	Mini-jack Stereo x 1				
	Composite video x 1				
	HDMI (MHL) x 1, HDMI x 1				
	Audio RCA (R/L) x 1				
	3D Sync in x 1				
	HDBaseT x 1				

<b>Output Terminals</b>	VGA x 1
	Audio RCA (R/L) x 1
	USB Type A for power support on WHDI x 1
	3D-Sync out x 1
<b>Control Terminals</b>	RS-232 in x 1 ( for serial in for control )
	RS-232 out x 1 (serial out for Pass thru Daisy Chain)
	RJ45 x 1
	Screen Trigger : DC Jack x 1 (DC12V 200mA output function)
	Wired Remote In x 1
	Wired Remote Out x 1
	USB Type B for service x 1
<b>Security</b>	Kensington Security Slot
	Security Bar

**Note:** For questions regarding product specifications, please contact your local distributor.

## Projection Distance vs. Projection Size

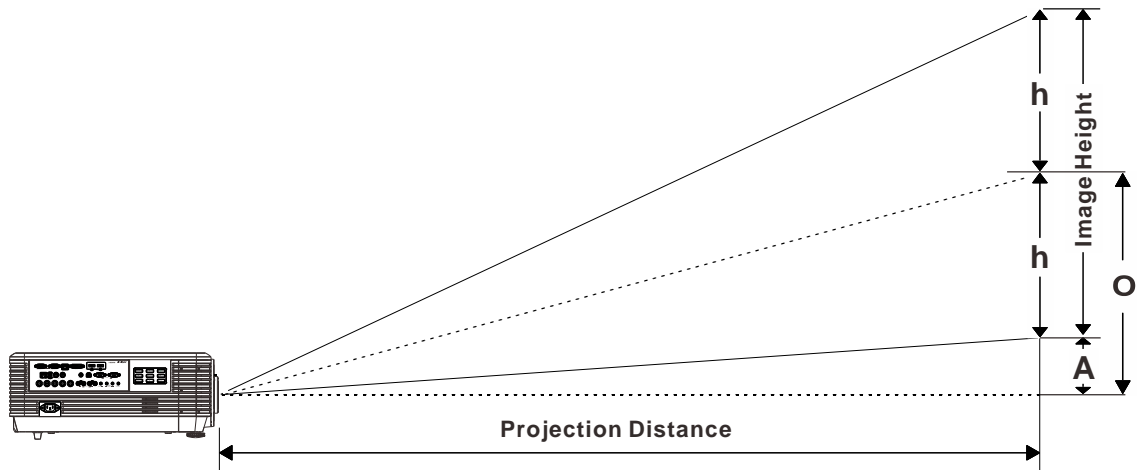

### Projection Distance and Size Table

New Short throw projection lens: TR: 0.778; offset=55%

	Fix			
Distance (m)	0.67	1.34	1.68	2.51
Diagonal (")	40	80	100	150
Image Width (mm)	862	1723	2154	3231
Image Height (mm)	538	1077	1346	2019
h (mm)	269	538	673	1010
O (mm)	296	592	740	1111
A (mm)	27	54	67	101

Semi Short throw projection lens: TR: 1.1 ~ 1.3; offset=55%

	TELE				WIDE			
Distance (m)	1.12	2.80	5.60	8.96	1.18	3.55	7.11	9.00
Diagonal (")	40	100	200	320	50	150	300	380
Image Width (mm)	862	2154	4308	6893	1077	3231	6462	8185
Image Height (mm)	538	1346	2692	4308	673	2019	4039	5116
h (mm)	269	673	1346	2154	337	1010	2019	2558
O (mm)	296	740	1481	2369	370	1111	2221	2814
A (mm)	27	67	135	215	34	101	202	256



Standard projection lens: TR: 1.54 ~ 1.93; offset=55%

	TELE				WIDE			
Distance (m)	1.66	3.33	4.16	8.31	1.66	3.32	6.63	9.95
Diagonal (")	40	80	100	200	50	100	200	300(*)
Image Width (mm)	862	1723	2154	4308	1077	2154	4308	6462
Image Height (mm)	538	1077	1346	2692	673	1346	2692	4039
h (mm)	269	538	673	1346	337	673	1346	2019
O (mm)	296	592	740	1481	370	740	1481	2221
A (mm)	27	54	67	135	34	67	135	202

**Note:**  
(\*) Overdrive.

Long throw projection lens: TR: 1.93 ~ 2.9; offset=55%

	TELE				WIDE			
Distance (m)	2.5	6.25	12.49	18.74	2.08	6.24	12.47	18.71
Diagonal (")	40	100	200	300	50	150	300	450
Image Width (mm)	862	2154	4308	6462	1077	3231	6462	9693
Image Height (mm)	538	1346	2692	4039	673	2019	4039	6058
h (mm)	269	673	1346	2019	337	1010	2020	3029
O (mm)	296	740	1481	2221	370	1111	2222	3332
A (mm)	27	67	135	202	34	101	202	303

Super Long throw projection lens: TR: 3 ~ 5; offset=55%

	TELE				WIDE			
Distance (m)	3.23	10.77	16.15	19.92	3.23	6.46	12.92	20.03
Diagonal (")	30	100	150	185	50	100	200	310
Image Width (mm)	646	2154	3231	3985	1077	2154	4308	6677
Image Height (mm)	404	1346	2019	2490	673	1346	2692	4173
h (mm)	202	673	1010	1245	337	673	1346	2087
O (mm)	222	740	1111	1370	370	740	1481	2295
A (mm)	20	67	101	125	34	67	135	209

offset % =  $O/(2 \times h) \times 100\%$

$O=A+h$

$h=(1/2) \times (\text{image height})$

## Timing Mode Table

### Table of Supported Frequency

The unit automatically determines PC signals to select the appropriate resolution. Some signals may require manual adjustment.

SIGNAL	RESOLUTION	H-SYNC ( KHz )	V-SYNC ( Hz )	COMPOSITE	COMPONENT	RGB/BNC (ANALOG)	DVI/HDMI/HDBASET (DIGITAL)
NTSC	—	15.734	60.0	○	—	—	—
PAL/SECAM	—	15.625	50.0	○	—	—	—
VESA	640 x 400	37.9	85.08	—	—	○	○
	720 x 400	31.5	70.1	—	—	○	○
	720 x 400	37.9	85.04	—	—	○	○
	640 x 480	31.5	60.0	—	—	○	○
	640 x 480	37.9	72.8	—	—	○	○
	640 x 480	37.5	75.0	—	—	○	○
	640 x 480	43.3	85.0	—	—	○	○
	800 x 600	35.2	56.3	—	—	○	○
	800 x 600	37.9	60.3	—	—	○	○
	800 x 600	46.9	75.0	—	—	○	○
	800 x 600	48.1	72.2	—	—	○	○
	800 x 600	53.7	85.1	—	—	○	○
	800 x 600	76.3	120.0	—	—	○	○
	1024 x 576	35.8	60.0	—	—	○	○
	1024 x 600	37.3	60.0	—	—	○	○
	1024 x 600	41.5	65.0	—	—	○	○
	1024 x 768	48.4	60.0	—	—	○	○
	1024 x 768	56.5	70.1	—	—	○	○
	1024 x 768	60.0	75.0	—	—	○	○
	1024 x 768	68.7	85.0	—	—	○	○
	1024 x 768	97.6	120.0	—	—	○	○
	1024 x 768	99.0	120.0	—	—	○	○
	1152 x 864	67.5	75.0	—	—	○	○
	1280 x 720	45.0	60.0	—	—	○	○
	1280 x 720	90.0	120.0	—	—	○	○
	1280 x 768	47.4	60.0	—	—	○	○
	1280 x 768	47.8	59.9	—	—	○	○
	1280 x 800	49.7	59.8	—	—	○	○
	1280 x 800	62.8	74.9	—	—	○	○
	1280 x 800	71.6	84.9	—	—	○	○
	1280 x 800	101.6	119.9	—	—	○	○
	1280 x 1024	64.0	60.0	—	—	○	○
1280 x 1024	80.0	75.0	—	—	○	○	
1280 x 1024	91.1	85.0	—	—	○	○	

SIGNAL	RESOLUTION	H-SYNC ( KHZ )	V-SYNC ( Hz )	COMPOSITE	COMPONENT	RGB/BNC (ANALOG)	DVI/HDMI/ HDBASET (DIGITAL)
	1280 x 960	60.0	60.0	—	—	○	○
	1280 x 960	85.9	85.0	—	—	○	○
	1360 x 768	47.7	60.0	—	—	○	○
	1400 x 1050	65.3	60.0	—	—	○	○
	1440 x 900	55.5	59.9	—	—	○	○
	1440 x 900	55.9	59.9	—	—	○	○
	1440 x 900	70.6	75.0	—	—	○	○
	1600 x1200	75.0	60	—	—	○	○
	1680 x 1050	64.7	59.9	—	—	○	○
	1680 x 1050	65.3	60.0	—	—	○	○
	1920 x 1200	74.0	60.0	—	—	○	○
	1920 x 1080	67.5	60.0	—	—	○	○
Apple Macintosh	640 x 480	35.0	66.7	—	—	○	○
	832 x 624	49.7	74.5	—	—	○	○
	1024 x 768	60.2	74.9	—	—	○	○
	1152 x 870	68.7	75.1	—	—	○	○
SDTV	480i	15.734	60.0	—	○	—	○
	576i	15.625	50.0	—	○	—	○
EDTV	576p	31.3	50.0	—	○	—	○
	480p	31.5	60.0	—	○	—	○
HDTV	720p	37.5	50.0	—	○	—	○
	720p	45.0	60.0	—	○	—	○
	1080i	33.8	60.0	—	○	—	○
	1080i	28.1	50.0	—	○	—	○
	1080p	27	24.0	—	○	—	○
	1080p	28	25.0	—	○	—	○
	1080p	33.7	30.0	—	○	—	○
	1080p	56.3	50.0	—	○	—	○
	1080p	67.5	60.0	—	○	—	○

O: Frequency supported

—: Frequency not supported

★The native resolution of the panel is 1280 x 800.

Resolution other than native resolution may be display with uneven size of text or line.

★The color of  mean Displayable only. (4:3 only)

★The color of  mean may have a little noise is acceptable.

★HDTV timing main check tool is DVD player, VG828 is secondary

**Table of Supported Frequency For 3D mode**

The unit automatically determines PC signals to select the appropriate resolution. Some signals may require manual adjustment.

***Input Signal for D-SUB/HDMI/DVI-D***

SIGNAL	RESOLUTION	REFRESH RATE(Hz)
SVGA	800 X 600	60/120
XGA	1024 X 768	60/120
HDTV(720P)	1280 X 720	60/120
WXGA	1280 X 800	60/120

***True 3D Video Compatibility table***

Input Resolutions	HDMI 1.4a 3D Input	Input timing		
		1280 X 720P @ 50Hz	Top - and - Bottom	
		1280 X 720P @ 60Hz	Top - and - Bottom	
		1280 X 720P @ 50Hz	Frame packing	
		1280 X 720P @ 60Hz	Frame packing	
		1920 X 1080i @50 Hz	Side- by-Side (Half)	
		1920 X 1080i @60 Hz	Side- by-Side (Half)	
		1920 X 1080P @24 Hz	Top - and – Bottom	
		1920 X 1080P @24 Hz	Frame packing	
	HDMI 1.3	1920 x 1080i @ 50Hz 1920 x1080i @ 60Hz 1280 x 720P @50Hz 1280 x 720P @60Hz	Side-by-Side(Half)	SBS mode is on
		1920 x 1080i @ 50Hz 1920 x1080i @ 60Hz 1280 x 720P @50Hz 1280 x 720P @60Hz	Top-and-Bottom	TAB mode is on
		480i	HQFS	3D format is Frame sequential

**Note:**  
3D glasses must be supported to 144Hz.

## Projector Dimensions

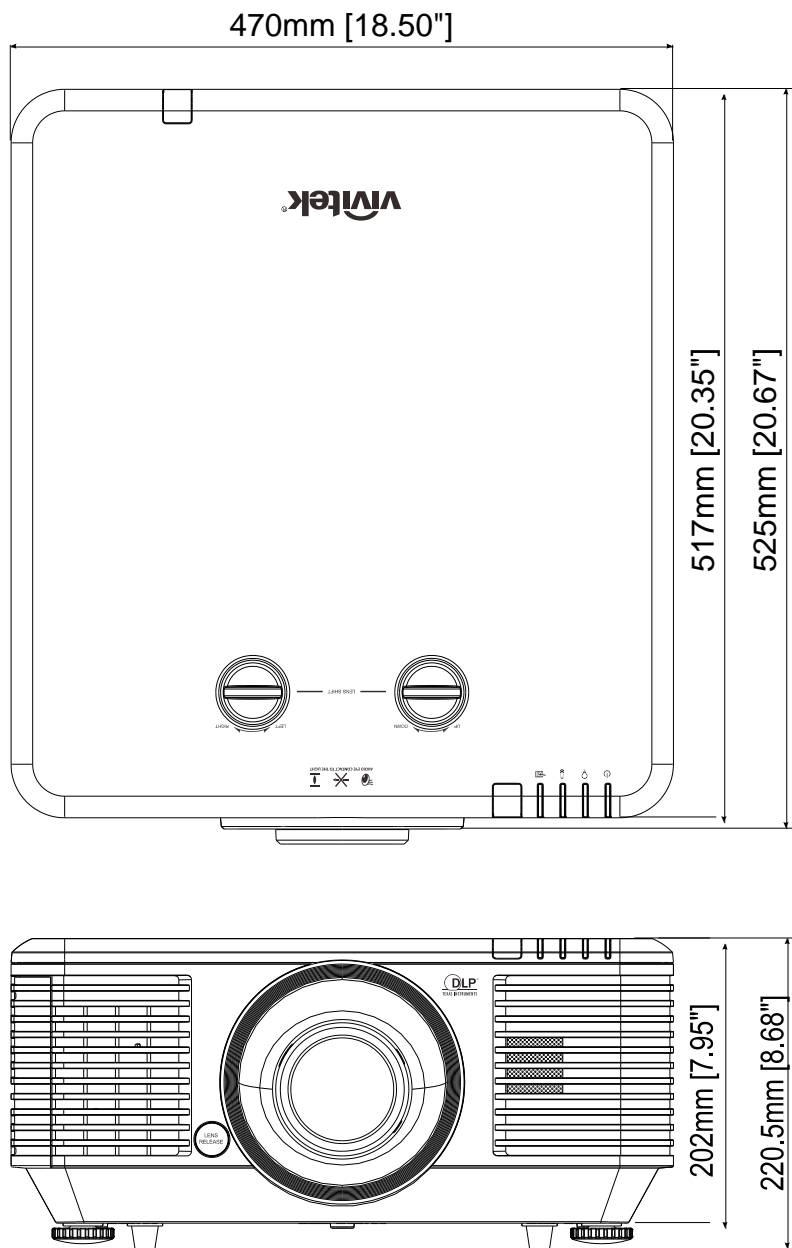

## **REGULATORY COMPLIANCE**

### **FCC Warning**

This equipment has been tested and found to comply with the limits for a Class B digital device pursuant to Part 15 of the FCC Rules. These limits are designed to provide reasonable protection against harmful interference when the equipment is operated in a commercial environment.

This equipment generates, uses, and can radiate radio frequency energy and, if not installed and used in accordance with the instruction manual, may cause harmful interference to radio communications. Operation of this equipment in a residential area is likely to cause harmful interference in which case the user will be required to correct the interference at his/her own expense.

Changes or modifications not expressly approved by the parties responsible for compliance could void the user's authority to operate the equipment.

### **Canada**

This class B digital apparatus complies with Canadian ICES-003.

### **Safety Certifications**

FCC-B, cUL, UL, CB, CE, CCC, KC, PCT, NOM, China CECP, and C-tick.

## Communication parameter setup

You can use the serial control command to input commands for projector control or retrieve its operational data through Windows client terminal software,

e.g. Hyper Terminal, with ASCII characters. You need to set up the following communication parameters in advance:

Item	Parameter:
Bit per Second	9600 bps
Data Bit	8-bit
Parity	None
Stop Bit	1
Flow Control	None

OSD Function	Operation command	Settings/Return Values	Note
Picture Mode	pic.mode	? = 0:Presentation 1:Bright 2:Game 3:Movie 4:Vivid 5:TV 6:sRGB 8:DICOM SIM 9:User1 10:User2	Not applicable when the project is in standby mode.
Input Select	input.sel	? = 1 = VGA1 3 = DVI 4 = Video 6 = HDMI 1 7 = BNC 9 = HDMI 2 15 = HDBASET	Not applicable when the project is at below status. *Standby mode
Auto Power Off	auto.powoff	? = 0-180	Not applicable when the project is in standby mode
Auto Power On	auto.powon	? = 0 = Off 1 = On	Not applicable when the project is in standby mode
Blank Screen	no.signal	? = 0 = Black 1 = Red 2 = Green 3 = Blue 4 = White	Not applicable when the project is in standby mode
Contrast	contrast	? = + - 0-100	Not applicable when the project is in standby mode or the input signal is not locked yet.
Brightness	bright	? = + - 0-100	Not applicable when the project is in standby mode or the input signal is not locked yet.
Saturation	saturat	? = + -- 0-100	a. Apply for YUV signal input b. Not applicable when the project is in standby mode or the input signal is not locked yet.

OSD Function	Operation command	Settings/Return Values	Note
Hue	tint	? = + - 0-100	a. Apply for YUV signal input b. Not applicable when the project is in standby mode or the input signal is not locked yet.
Sharpness	sharp	? = + - 0-31	Not applicable when the project is in standby mode or the input signal is not locked yet.
Color Temperature	color.temp	? = 0 = Warm 1 = Normal 2 = Cold	Not applicable when the project is in standby mode or the input signal is not locked yet.
White Balance /Red Offset	red.offset	? = + - -100 ~ +100	Not applicable when the project is in standby mode or the input signal is not locked yet.
White Balance /Green Offset	green.offset	? = + - -100 ~ +100	Not applicable when the project is in standby mode or the input signal is not locked yet.
White Balance /Blue Offset	blue.offset	? = + - -100 ~ +100	Not applicable when the project is in standby mode or the input signal is not locked yet.
White Balance /Red Gain	red.gain	? = + - 0-200	Not applicable when the project is in standby mode or the input signal is not locked yet.
White Balance /Green Gain	green.gain	? = + - 0-200	Not applicable when the project is in standby mode or the input signal is not locked yet.
White Balance /Blue Gain	blue.gain	? = + - 0-200	Not applicable when the project is in standby mode or the input signal is not locked yet.
HSG/Red Gain	hsg.r.gain	? = + - 0-100	Not applicable when the project is in standby mode or the input signal is not locked yet.
HSG/Green Gain	hsg.g.gain	? = + - 0-100	Not applicable when the project is in standby mode or the input signal is not locked yet.
HSG/Blue Gain	Hsg.b.gain	? = + - 0-100	Not applicable when the project is in standby mode or the input signal is not locked yet.
HSG/Cyan Gain	hsg.c.gain	? = + - 0-100	Not applicable when the project is in standby mode or the input signal is not locked yet.
HSG/Magenta Gain	hsg.m.gain	? = + - 0-100	Not applicable when the project is in standby mode or the input signal is not locked yet.
HSG/Yellow Gain	hsg.y.gain	? = + - 0-100	Not applicable when the project is in standby mode or the input signal is not locked yet.
HSG/Red/Saturation	hsg.r.sat	? = + - 0-100	Not applicable when the project is in standby mode or the input signal is not locked yet.
HSG/Green/Saturation	hsg.g.sat	? = + - 0-100	Not applicable when the project is in standby mode or the input signal is not locked yet.



OSD Function	Operation command	Settings/Return Values	Note	
HSG/Blue/Saturation	Hsg.b.sat	? = + -	0-100	Not applicable when the project is in standby mode or the input signal is not locked yet.
HSG/Cyan/Saturation	hsg.c.sat	? = + -	0-100	Not applicable when the project is in standby mode or the input signal is not locked yet.
HSG/Magenta/Saturation	hsg.m.sat	? = + -	0-100	Not applicable when the project is in standby mode or the input signal is not locked yet.
HSG/Yellow/Saturation	Hsg.y.sat	? = + -	0-100	Not applicable when the project is in standby mode or the input signal is not locked yet.
HSG/Red/Hue	hsg.r.hue	? = + -	0-100	Not applicable when the project is in standby mode or the input signal is not locked yet.
HSG/Green/Hue	hsg.g.hue	? = + -	0-100	Not applicable when the project is in standby mode or the input signal is not locked yet.
HSG/Blue/Hue	Hsg.b. hue	? = + -	0-100	Not applicable when the project is in standby mode or the input signal is not locked yet.
HSG/Cyan/Hue	hsg.c. hue	? = + -	0-100	Not applicable when the project is in standby mode or the input signal is not locked yet.
HSG/Magenta/Hue	hsg.m. hue	? = + -	0-100	Not applicable when the project is in standby mode or the input signal is not locked yet.
HSG/Yellow/Hue	Hsg.y. hue	? = + -	0-100	Not applicable when the project is in standby mode or the input signal is not locked yet.
HSG/White/Red Gain	hsg.wr.gain	? = + -	0-100	Not applicable when the project is in standby mode or the input signal is not locked yet.
HSG/White/Green Gain	hsg.wg.gain	? = + -	0-100	Not applicable when the project is in standby mode or the input signal is not locked yet.
HSG/White/Blue Gain	Hsg.wb.gain	? = + -	0-100	Not applicable when the project is in standby mode or the input signal is not locked yet.
Aspect Ratio	aspect	? = 0 = Fill 1 = 4:3 2 = 16:9 3 = LetterBox 4 = Native 5 = 2.35:1	*Not applicable when the project is in standby mode or the input signal is not locked yet. *When the Zoom function is set to Zoom in, the Unscaled function is disabled.	
VGA Frequency	h.phase	? = + -	0-31	*Not applicable when the project is in standby mode or the input signal is not locked yet. *Apply for VGA and Component signal input.

OSD Function	Operation command	Settings/Return Values	Note	
VGA Tracking	h.total	? = + -	-5 ~ +5	*Not applicable when the project is in standby mode or the input signal is not locked yet. *Apply for VGA and Component signal input.
VGA H Position	h.pos	? = + -	-5 ~ +5 -100 ~ +100(Auto Sync Off)	*Not applicable when the project is in standby mode or the input signal is not locked yet. *Apply for VGA and Component signal input.
VGA V Position	v.pos	? = + -	-5 ~ +5 -100 ~ +100(Auto Sync Off)	*Not applicable when the project is in standby mode or the input signal is not locked yet. *Apply for VGA and Component signal input.
Auto Sync	auto.img		(execute)	Not applicable when the project is in standby mode or the input signal is not locked yet.
Zoom	zoom	? =	-10 ~ +10	The Lens control command does not apply when the projector is in standby mode.
Lamp Mode	Lamp.mode	? =	0: Normal 1: Eco 2: Eco plus 3: Dimming 4: Extere dimming 5: Custom	*Not applicable when the project is in standby mode *Not applicable when the project is in cooling or lighting up status. Please send control command after the said commands are completed.
Fan Speed	altitude	? =	0 = Normal 1 = High	Not applicable when the project is in standby mode
Lamp 1 Statu	lamp1.stat	? =	0 = Off 1 = On	Not applicable in standby mode
Projection Mode	proj.mode	? =	0 = Desktop Front 1 = Desktop Rear 2 = Ceiling Front 3 = Ceiling Rear	Not applicable when the project is in standby mode
Gamma	gamma	? =	0 = 1.8 1 = 2.0 2 = 2.2 3 = 2.4 4 = B&W 5 = Linear	Not applicable when the project is in standby mode or the input signal is not locked yet.
Test Pattern	pattern	? =	0 = None 1 = RGB Ramps 2 = Color Bars 3 = Setp Bars 4 = Checkboard 5 = Grid 6 = Horizontal Lines 7 = Vertical Lines 8 = Diagonal Lines 9 = Horizontal Ramp 10 = Vertical Ramp 11 = White 12 = Red 13 = Green 14 = Blue 15 = Black	Not applicable when the project is in standby mode.
V Keystone	v.keystone	? = + -	-30 ~ 30	Not applicable when the projector is in standby mode.
H Keystone	h.keystone	? = + -	-25 ~ 25	Not applicable when the projector is in standby mode.
Network/IP Adress	net.ipaddr	? =	<string>	Not applicable when the project is in standby mode

OSD Function	Operation command	Settings/Return Values	Note
Network/Subnet	net.subnet	? = <string>	Not applicable when the project is in standby mode
Network/Gateway	net.gateway	? = <string>	Not applicable when the project is in standby mode
Network/DHCP	net.dhcp	? = 0 = Off 1 = On	Not applicable when the project is in standby mode
Menu Position	menu.pos	? = 0 ~ 4	Not applicable when the project is in standby mode
Startup Logo	startup.logo	? = 0 = STD 1 = Black 2 = Blue	Not applicable when the project is in standby mode
Auto Search	auto.src	? = 0 = Off 1 = On	Not applicable when the projector is in standby mode.
Language	lang	? = 0 = English 1 = French 2 = German 3 = Spanish 4 = Portugues 5 = Simplified Chinese 6 = Traditional Chinese 7 = Italian 8 = Norwegian 9 = Swedish 10 = Dutch 11 = Russian 12 = Polish 13 = Finnish 14 = Greek 15 = Korean 16 = Hungarian 17 = Czech 18 = Arabic 19 = Turkish 20 = Vietnamese 21 = Japanese 22 = Thai 23 = Farsi 24 = Hebrew 25 = Danish 26 = French Canadian	
Model	model	? <String>	
Serial Number	ser.no	? <String>	
Software Version	sw.ver	? <String>	
Active Source	Act.src	? 1 = VGA1 3 = DVI 4 = Video 6 = HDMI 1 7 = BNC 9 = HDMI 2 15 = HDBASET	
Pixel Clock	pixel.clock	? <String>	*In unit of MHz *Not applicable when the project is in standby mode or the input signal is not locked yet.
Signal Format	signal	? <String>	Not applicable when the project is in standby mode or the input signal is not locked yet.
H Refresh Rate	h.refresh	? <String>	Not applicable when the project is in standby mode or the input signal is not locked yet.
V Refresh Rate	v.refresh	? <String>	Not applicable when the project is in standby mode or the input signal is not locked yet.
Lamp1.Time	lamp1.hours	? <String>	
Lamp1 Time Reset	Lamp1.reset	(execute)	Reset All of lamp time

OSD Function	Operation command	Settings/Return Values	Note
Power On Time	proj.runtime	? <String>	
Factory Reset	fact.reset	(execute)	
Blank	Picture.mute	? = 0 = Off 1 = On	
Power On	power.on	(execute)	Not applicable in active mode
Power Off	power.off	(execute)	Not applicable in standby mode
Projector Status	status	? 0 = Reset 1 = Standby 2 = Active 3 = cooling	
Low Power Mode	lowpower.mode	? = 1 = On 2 = On By Lan	
3D Sync	threed.mode	? = 0 = Off 1 = DLP-Link 2 = IR	Auto 3D (1080P 24Hz) can not Off
3D Sync Invert	threed.sync.invert	? = 0 = Off 1 = On	Active in DLP-LINK
3D Sync Format	threed.format	? = 0 = Frame Sequential 1 = Top / Bottom 2 = Side by side 3 = Frame Packing	Function available dependent on input source & timing.

**Note:**

*The projector returns string "NA" when the input command does not apply to current projector status or setup.*